

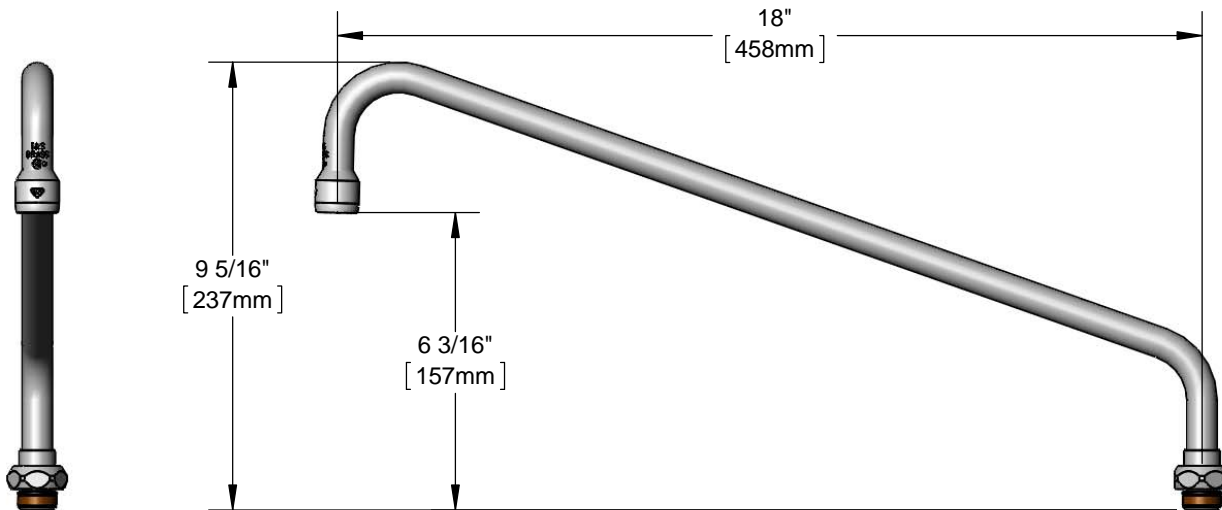

Architect/Engineering Specifications:

18" swing nozzle with 2.2 GPM aerator. Certified to ASME A112.18.1/CSA B125.1, NSF 61-Section 9 and NSF 372.

Job Name _____
 Model Specified _____ Quantity _____
 Variations Specified _____
 Date _____

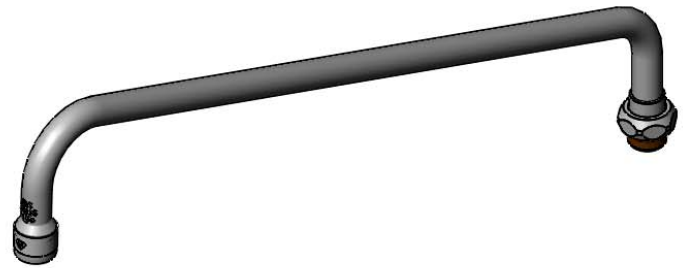

Features & Benefits:

- 18" swing nozzle
- 2.2 GPM aerator, Series 1 (B-0199-01)
- Fits all T&S swivel outlet faucets
- Material: Chrome plated brass tubular spout

Product Compliance:

- ASME A112.18.1 / CSA B125.1
- NSF 61 - Section 9
- NSF 372 (Low Lead Content)

Warranty: One Year (Limited)



Performance Data:

- Pressure: 20 - 125 psi
- Temperature: 40 °F - 140 °F
- Flow Rate: 2.2 GPM @ 60 psi



Optional Outlets (Series 1 / VR Series 6)

GPM	Aerated	Non-Aerated (Laminar)	VR Aerated	VR Non-Aerated (VR Laminar)
0.35	N/A	<input type="checkbox"/> B-0199-01-N035	N/A	<input type="checkbox"/> B-0199-06-N035
0.5	N/A	<input type="checkbox"/> B-0199-01-N05	N/A	<input type="checkbox"/> B-0199-06-N05
1.0	<input type="checkbox"/> B-0199-01-F10	N/A	<input type="checkbox"/> B-0199-06-F10	N/A
1.5	<input type="checkbox"/> B-0199-01-WS	<input type="checkbox"/> B-0199-29	<input type="checkbox"/> B-0199-06-WS	<input type="checkbox"/> B-0199-29VR
2.2	Standard	<input type="checkbox"/> B-0199-21	<input type="checkbox"/> B-0199-06	<input type="checkbox"/> B-0199-21-VRF

