

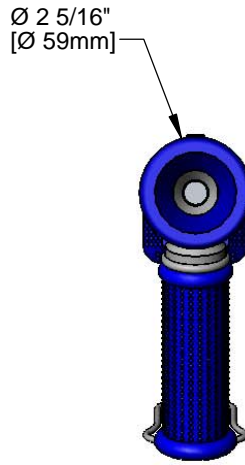

Architect/Engineering Specifications:

Heavy duty rear trigger water gun, stainless steel with blue rubber cover, Ø 9/16" flow orifice and 1/2" NPT x 1" hose barb connector.

Job Name _____
Model Specified _____ Quantity _____
Variations Specified _____
Date _____

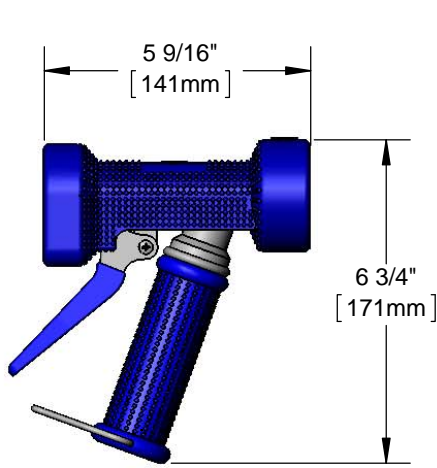

Features & Benefits:

- Heavy duty rear trigger water gun
- Stainless steel with blue rubber cover
- High flow washdown water gun
- Rubber covered trigger
- Ø 9/16" flow orifice
- 1/2" NPT x 1" hose barb connector
- Material: Stainless steel and rubber

Product Compliance:

- NSF 61 Exempt (Non-Potable)

Warranty: One Year (Limited)

Performance Data:

- Pressure: 20 - 125 psi
- Temperature: 40 °F - 200 °F
- Flow Rate: 10.10 GPM @ 60 psi

