



# Pre-Rinse Units

## MPY-2DWV-08-CR

TAG:

**EasyInstall** Mini Pre-Rinse Unit

### Architect/Engineering Specifications:

Single hole deck mount mixing faucet with polished chrome plated brass body, add-on faucet with ceramic cartridge and wrist action handle, 8" swing nozzle with stream regulator outlet, 5 3/16" riser, vacuum breaker, 24" flexible stainless steel hose with heat resistant handle, 0.65 GPM low flow spray valve, ceramic cartridges with check valves, wrist action handles, 18" flexible stainless steel supply hoses with 1/2" NPSM / 5/8" compression connections, 6" adjustable wall bracket, spray valve holder and overhead spring. Certified to ASME A112.18.1/CSA B125.1, NSF 61-Section 9 and NSF 372. EPAAct 2005 compliant.

Job Name \_\_\_\_\_  
 Model Specified \_\_\_\_\_ Quantity \_\_\_\_\_  
 Variations Specified \_\_\_\_\_  
 Date \_\_\_\_\_

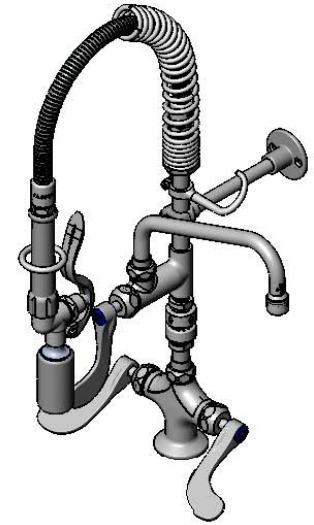
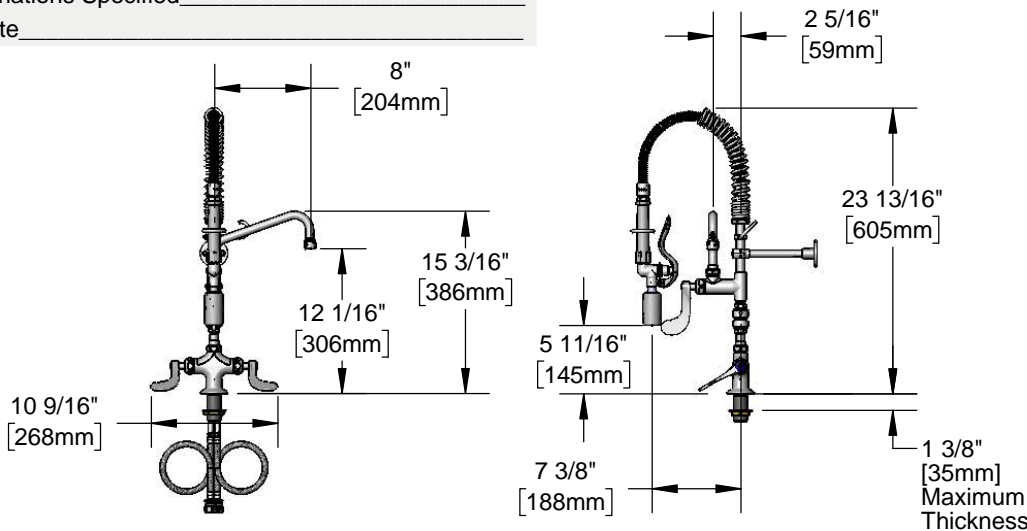

### Features & Benefits:

- Single hole deck mount mixing faucet w/ polished chrome plated brass body & Ø 2 1/4" deck flange
- EasyInstall add-on faucet w/ polished chrome plated brass body
- Continuous pressure vacuum breaker
- 8" swing nozzle w/ stream regulator outlet, Series 1
- 5 3/16" rigid riser
- 24" flexible stainless steel hose w/ heat resistant gray handle and hold down ring
- 0.65 GPM low flow spray valve
- Quarter-turn Cerama cartridges with check valves to prevent cross flow of water
- 4" wrist action handles w/ color coded indexes
- 18" flexible stainless steel supply hoses w/ 1/2" NPSM / 5/8" compression connections
- 6" adjustable wall bracket
- Material: Polished chrome plated brass body & tubular nozzle, add-on faucet body, riser, vacuum breaker & spray valve, stainless steel hose and chrome plated metal handles

### Product Compliance:

- ASME A112.18.1 / CSA B125.1
- NSF 61 - Section 9
- NSF 372 (Low Lead Content)
- EPAAct 2005 (PRSV)
- EPA WaterSense (PRSV)
- CSA B64.8 (VB)
- For Commercial use Only



### Warranty: Three Year (Limited)

- Cerama Cartridge: Lifetime (Limited)

### Performance Data:

- Pressure: 20 - 125 psi
- Temperature: 40°F - 140°F
- Flow Rate:
  - Spray Valve: 0.65 GPM @ 60 psi
  - Add-On Faucet: 4.51 GPM @ 60 psi

### Optional Cartridges With Checks

- Quarter-Turn Cerama w/ Check Valve (Standard)
- Quarter-Turn Eterna w/ Spring Check

### Optional Handles

- 4" Wrist Action (Standard)
- Lever
- 4-Arm

### Optional Pre-Rinse Spray Valves

- B-0107 (1.42 GPM)
- B-0107-C (0.65 GPM) (Standard)
- B-0107-J (1.07 GPM)
- B-0108 (1.48 GPM)
- B-0108-C (0.65 GPM)

### Optional Add-On Faucet Outlets (Series 1 / VR Series 6)

GPM	Aerated	VR Aerated (VR Laminar)
1.0	<input type="checkbox"/> B-0199-01-F10	<input type="checkbox"/> B-0199-06-F10
1.5	<input type="checkbox"/> B-0199-01-WS	<input type="checkbox"/> B-0199-06-WS
2.2	<input type="checkbox"/> B-0199-01	<input type="checkbox"/> B-0199-06



T&S BRASS AND BRONZE WORKS, INC.



• 2 Saddleback Cove • Travelers Rest, SC 29690  
 Ph 800-476-4103 • Fax 864-834-3518  
 • Simi Valley, CA • Ph 800-423-0150 • www.tsbrass.com

Date: 05/05/17