

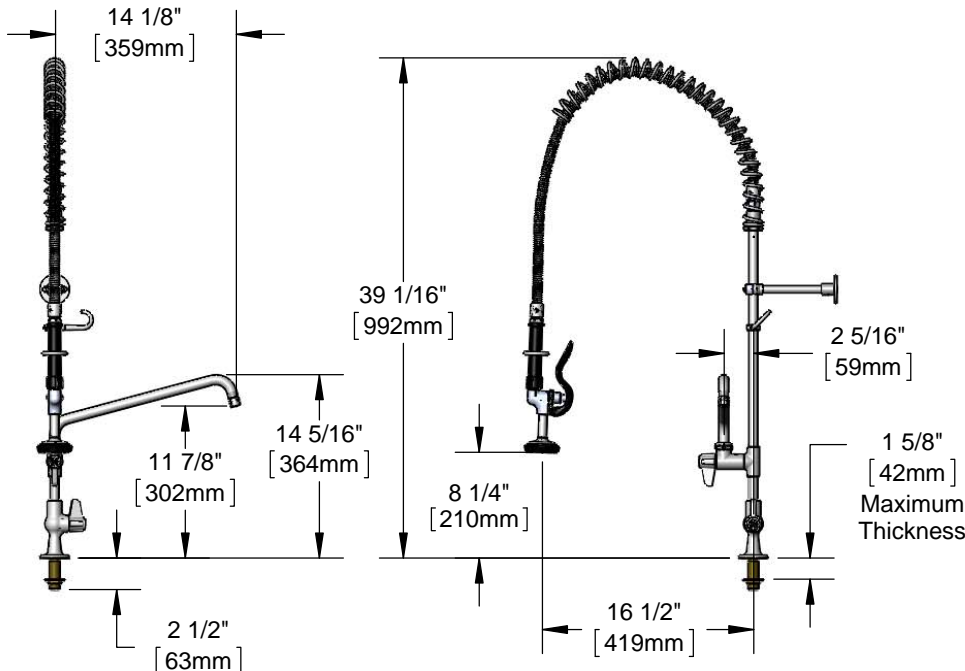

#### Architect/Engineering Specifications:

Single hole deck mount faucet with polished chrome plated brass body, add-on faucet with ceramic cartridge and lever handle, 14 1/8" swing nozzle with laminar flow device, 18" riser, 44" flexible stainless steel hose with heat resistant handle, 1.42 GPM spray valve, ceramic cartridge, lever handle, 1/2" NPT male inlet, adjustable wall bracket, spray valve holder and overhead spring. Certified to ASME A112.18.1/CSA B125.1, NSF 61-Section 9 and NSF 372. EPAAct 2005 compliant.

Job Name \_\_\_\_\_  
 Model Specified \_\_\_\_\_ Quantity \_\_\_\_\_  
 Variations Specified \_\_\_\_\_  
 Date \_\_\_\_\_



#### Features & Benefits:

- Single hole deck mount mixing faucet w/ polished chrome plated brass body & Ø 2 1/4" deck flange
- Add-on faucet w/ polished chrome plated brass body
- 14 1/8" swing nozzle w/ laminar flow device
- 18" rigid riser
- 44" flexible stainless steel hose w/ heat resistant black handle and hold down ring
- 1.42 GPM spray valve
- Quarter-turn ceramic cartridge
- Lever handle w/ color coded screw
- 1/2" NPT male inlet
- 6" adjustable wall bracket
- Material: Polished chrome plated brass body & tubular nozzle, add-on faucet body, riser & spray valve, stainless steel hose and chrome plated metal handles

#### Product Compliance:

- ASME A112.18.1 / CSA B125.1
- NSF 61 - Section 9
- NSF 372 (Low Lead Content)
- EPAAct 2005 (PRSV)

**Warranty:** One Year (Limited)

#### Performance Data:

- Pressure: 20 - 125 psi
- Temperature: 40°F - 140°F
- Flow Rate:
  - Spray Valve: 1.42 GPM @ 60 psi
  - Add-On Faucet: 3.93 GPM @ 60 psi

