



Faucets

5F-4DWX08

TAG:

4" Deck Mount Faucet

Architect/Engineering Specifications:

4" deck mount mixing faucet with polished chrome plated brass body, 8" equip swivel swing nozzle with laminar full flow device, ceramic cartridges, equip 4" wrist action handles and 1/2" NPT female inlets. Certified to ASME A112.18.1\CSA B125.1, NSF 61-Section 9 and NSF 372. Meets ADA ANSNICC A117.1 requirements.

Job Name _____
 Model Specified _____ Quantity _____
 Variations Specified _____
 Date _____

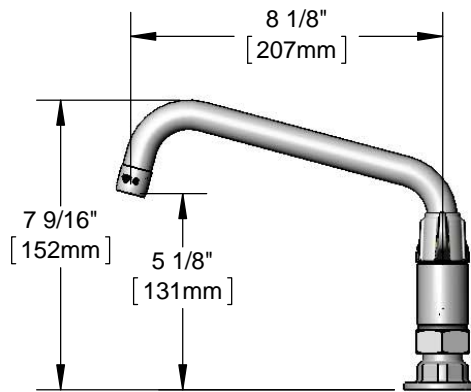
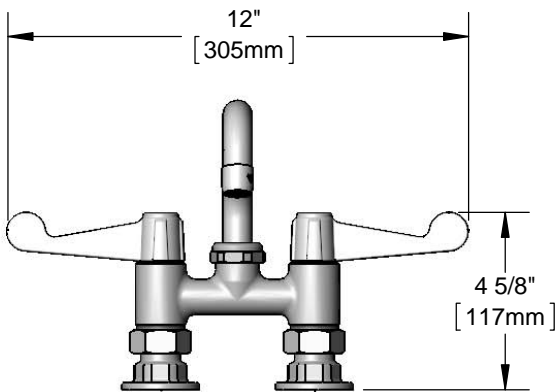
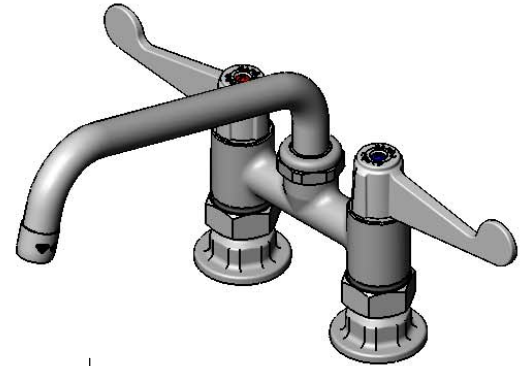

Features & Benefits:

- 4" deck mount mixing faucet w/ polished chrome plated brass body
- 8" equip swivel swing nozzle w/ laminar full flow device
- Quarter-turn ceramic cartridges
- equip 4" wrist action handles w/ color coded screws
- 1/2" NPT female eccentric inlets w/ $\varnothing 2$ " flanges
- Adjustable centers from 3 3/4" to 4 1/4"
- Material: Polished chrome plated brass body & tubular spout and chrome plated metal handles

Product Compliance:

- ASME A112.18.1 / CSA B125.1
- NSF 61 - Section 9
- NSF 372 (Low Lead Content)
- ANSI A117.1 (ADA)

Warranty: One Year (Limited)

Performance Data:

- Pressure: 20 - 125 psi
- Temperature: 40°F - 140°F
- Flow Rate: 5.20 GPM @ 60 psi



ADA Compliant



equip Foodservice Accessories



• 2 Saddleback Cove • Travelers Rest, SC 29690
Ph 800-891-4808 • Fax 800-868-0084
www.tsbrass.com

Date: 10/24/16