



Electronic Faucets
EC-3102-SMT4

TAG:



Electronic Sensor Faucet

Architect/Engineering Specifications:

4" combination faucet and side mount control, single hole deck mount electronic sensor faucet with polished chrome plated brass body with integral spout, 2.2 GPM vandal resistant aerator, AC/DC control module with internal flow control setting switches, above deck side mount adjustable thermostatic mixing valve with check valves, 18" flexible stainless steel supply hoses and 3/8" compression connections. Certified to ASME A112.18.1/CSA B125.1, NSF 61-Section 9, NSF 372, ASSE 1070 and UL 1951. Meets ADA ANSI/ICC A117.1 requirements.

Job Name _____
 Model Specified _____ Quantity _____
 Variations Specified _____
 Date _____

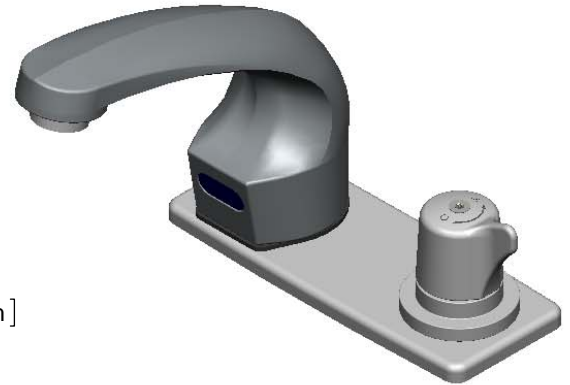
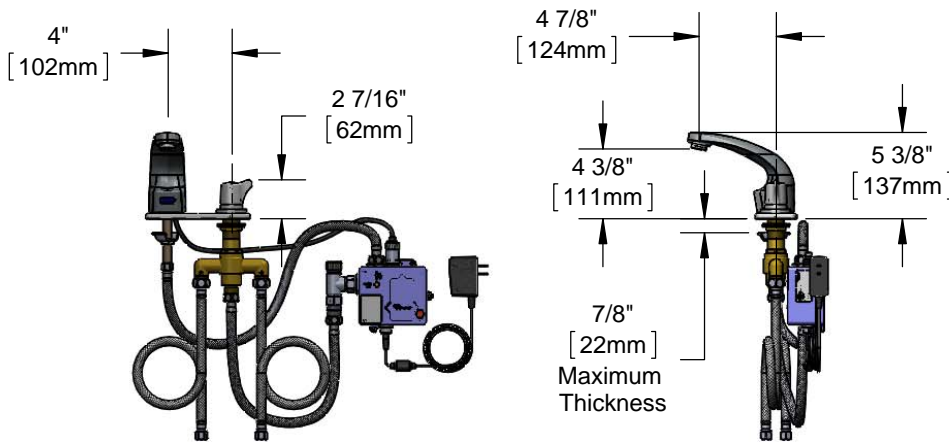

Features & Benefits:

- 4" combination faucet and side mount control
- Single hole, deck mount polished chrome plated brass body w/ integral spout
- 2.2 GPM vandal resistant aerator, Series 8 (B-0199-08)
- Water resistant control module w/ internal flow control switches for adjusting auto time out & shut off delay settings
- Optional auto flush feature flows water for 30 seconds after every 12 inactive hours
- Plug in AC transformer or (4) AA battery (DC) power options
- Above deck side mount adjustable thermostatic mixing valve w/ check valves
- 4" centerline polished chrome plated brass deck plate
- 18" flexible stainless steel supply hoses with 3/8" compression connections
- Low battery LED indicator light
- Material: Polished chrome plated brass body & deck plate and chrome plated metal handle

Product Compliance:

- ASME A112.18.1 / CSA B125.1
- NSF 61 - Section 9
- NSF 372 (Low Lead Content)
- ANSI A117.1 (ADA)
- UL 1951
- ASSE 1070 (TMV)

Warranty: Three Year (Limited)

Performance Data:

- Pressure: 20 - 125 psi
- Temperature: 40 °F - 140 °F
- Flow Rate: 2.2 GPM @ 60 psi
- Water Consumption: @ 10 sec = .37 gal
@ 15 sec = .55 gal



ADA Compliant



Optional Outlets (Series 3 / VR Series 8)

GPM	Aerated	Non-Aerated (Laminar)	VR Aerated	VR Non-Aerated (VR Laminar)
0.35	N/A	<input type="checkbox"/> B-0199-03-N035	N/A	<input type="checkbox"/> B-0199-08-N035
0.5	N/A	<input type="checkbox"/> B-0199-03-N05	N/A	<input type="checkbox"/> B-0199-08-N05
1.0	N/A	N/A	N/A	<input type="checkbox"/> B-0199-08-LF-10
1.5	<input type="checkbox"/> B-0199-03-WS	N/A	<input type="checkbox"/> B-0199-08-WS	N/A
2.2	<input type="checkbox"/> B-0199-03	<input type="checkbox"/> B-0199-26	Standard	<input type="checkbox"/> B-0199-28



T&S BRASS AND BRONZE WORKS, INC.



• 2 Saddleback Cove • Travelers Rest, SC 29690
 Ph 800-476-4103 • Fax 864-834-3518
 • Simi Valley, CA • Ph 800-423-0150 • www.tsbrass.com

Date: 08/26/16