



Electronic Faucets
EC-3100-XP-LF10



ChekPoint™

Electronic Sensor Faucet

TAG:

Architect/Engineering Specifications:

Single hole deck mount electronic sensor faucet with polished chrome plated brass body, rigid gooseneck with plain end, 1.0 GPM flow regulating check valve, AC/DC control module with internal flow control setting switches, temperature control mixing valve with check valves and 18" flexible stainless steel supply hoses with 3/8" compression connections. Certified to ASME A112.18.1/CSA B125.1, NSF 61-Section 9, NSF 372 and UL 1951. Meets ADA ANSI/ICC A117.1 requirements.

Job Name _____
 Model Specified _____ Quantity _____
 Variations Specified _____
 Date _____

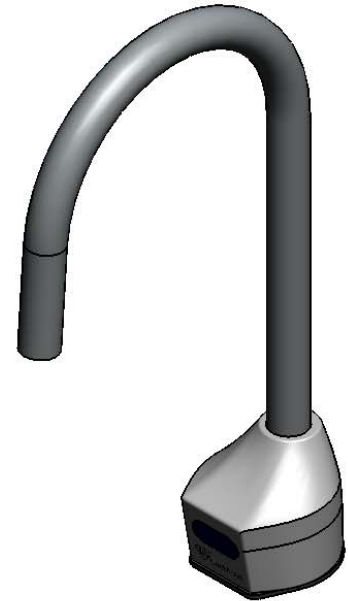
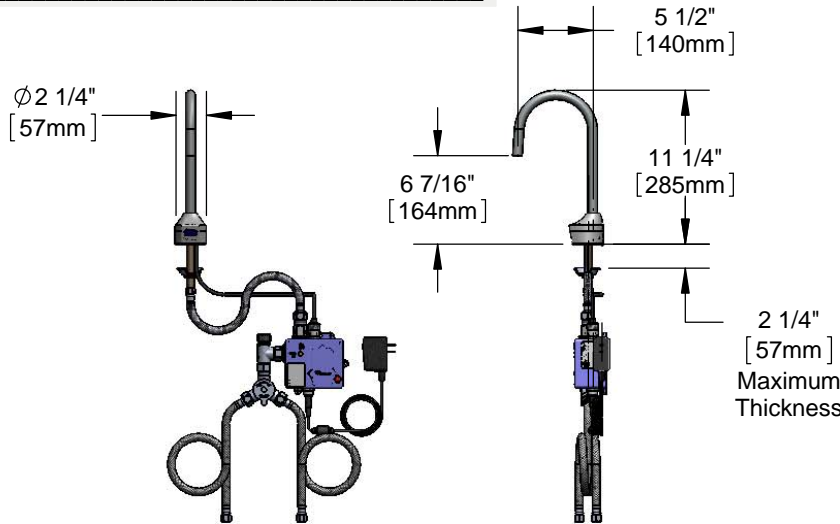

Features & Benefits:

- Single hole deck mount w/ polished chrome plated brass body
- 5 9/16" rigid gooseneck w/ plain end
- 1.0 GPM flow regulating check valve
- Water resistant control module w/ internal flow control switches for adjusting auto time out & shut off delay settings
- Optional auto flush feature flows water for 30 seconds after every 12 inactive hours
- Plug in AC transformer or (4) AA battery (DC) power options
- Mechanical temperature mixing valve w/ check valves
- 18" flexible stainless steel supply hoses w/ 3/8" compression connections
- Low battery LED indicator light
- Material: Polished chrome plated brass body & tubular spout

Product Compliance:

- ASME A112.18.1 / CSA B125.1
- NSF 61 - Section 9
- NSF 372 (Low Lead Content)
- ANSI A117.1 (ADA)
- UL 1951

Warranty: Three Year (Limited)

Performance Data:

- Pressure: 20 - 125 psi
- Temperature: 40°F - 140°F
- Flow Rate: 1.0 GPM @ 60 psi
- Water Consumption: @ 10 sec = .17 gal
@ 15 sec = .25 gal



ADA Compliant



T&S BRASS AND BRONZE WORKS, INC.



• 2 Saddleback Cove • Travelers Rest, SC 29690
 Ph 800-476-4103 • Fax 864-834-3518
 • Simi Valley, CA • Ph 800-423-0150 • www.tsbrass.com

Date: 08/26/16