



# Electronic Faucets

## EC-3100-BA

TAG:



### Electronic Sensor Faucet

#### Architect/Engineering Specifications:

Single hole deck mount electronic sensor faucet with polished chrome plated brass body and 4 1/8" rigid gooseneck, 2.2 GPM vandal resistant aerator, AC/DC control module with internal flow control setting switches, temperature control mixing valve with check valves and 18" flexible stainless steel supply hoses with 3/8" compression connections. Certified to ASME A112.18.1/CSA B125.1, NSF 61-Section 9, NSF 372 and UL 1951. Meets ADA ANSI/ICC A117.1 requirements.

Job Name \_\_\_\_\_  
 Model Specified \_\_\_\_\_ Quantity \_\_\_\_\_  
 Variations Specified \_\_\_\_\_  
 Date \_\_\_\_\_

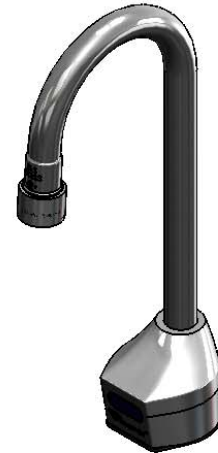
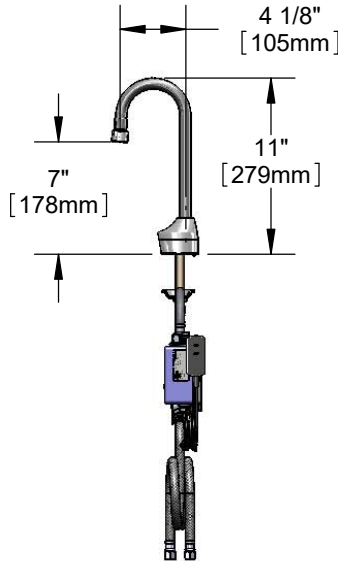
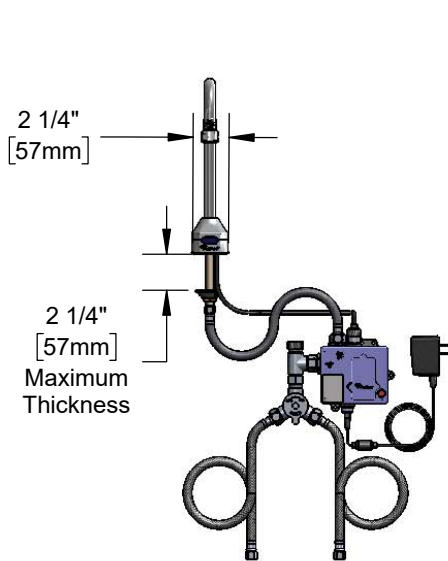

#### Features & Benefits:

- Single hole deck mount Faucet w/ polished chrome plated brass body
- 4 1/8" rigid gooseneck
- 2.2 GPM vandal resistant aerator, Series 7 (B-0199-07)
- Water resistant control module w/ internal flow control switches for adjusting auto time out & shut off delay settings
- Optional auto flush feature flows water for 30 seconds after every 12 inactive hours
- Plug in AC transformer or (4) AA battery (DC) power options
- Mechanical temperature mixing valve w/ check valves
- 18" flexible stainless steel supply hoses w/ 3/8" compression connections
- Low battery LED indicator light
- Material: Polished chrome plated brass body & tubular spout

#### Product Compliance:

- ASME A112.18.1 / CSA B125.1
- NSF 61 - Section 9
- NSF 372 (Low Lead Content)
- ANSI A117.1 (ADA)
- UL 1951



**Warranty:** Three Year (Limited)

#### Performance Data:

- Pressure: 20 - 125 psi
- Temperature: 40 °F - 140 °F
- Flow Rate: 2.2 GPM @ 60 psi
- Water Consumption: @ 10 sec = .37 gal  
@ 15 sec = .55 gal



ADA Compliant



#### Optional Outlets (Series 2 / VR Series 7)

GPM	Aerated	Non-Aerated (Laminar)	VR Aerated	VR Non-Aerated (VR Laminar)	Optional Deck Plates
0.35	N/A	<input type="checkbox"/> B-0199-02-N035	N/A	<input type="checkbox"/> B-0199-07-N035	<input type="checkbox"/> 4" Chrome Plated Brass Deck Plate
0.5	N/A	<input type="checkbox"/> B-0199-02-N05	N/A	<input type="checkbox"/> B-0199-07-N05	<input type="checkbox"/> 8" Chrome Plated Brass Deck Plate
1.0	<input type="checkbox"/> B-0199-02-F10	N/A	<input type="checkbox"/> B-0199-07-F10	N/A	
1.5	<input type="checkbox"/> B-0199-02-WS	N/A	<input type="checkbox"/> B-0199-07-WS	N/A	
2.2	<input type="checkbox"/> B-0199-02	N/A	Standard	N/A	



T&S BRASS AND BRONZE WORKS, INC.



• 2 Saddleback Cove • Travelers Rest, SC 29690  
 Ph 800-476-4103 • Fax 864-834-3518  
 • Simi Valley, CA • Ph 800-423-0150 • www.tsbrass.com

Date: 12/04/17