

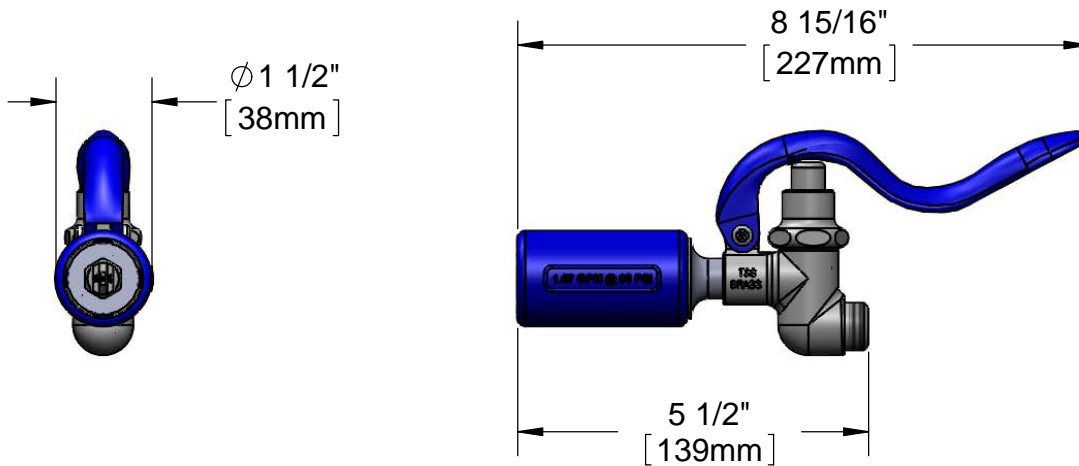

Architect/Engineering Specifications:

1.07 GPM spray valve, polished chrome plated brass body with blue rubber bumper and 3/4-14 UN male inlet. Certified to ASME A112.18.1/CSA B125.1, NSF 61-Section 9, NSF 372 and EPA WaterSense. EPAAct2005 compliant.

Job Name	_____
Model Specified	_____ Quantity _____
Variations Specified	_____
Date	_____

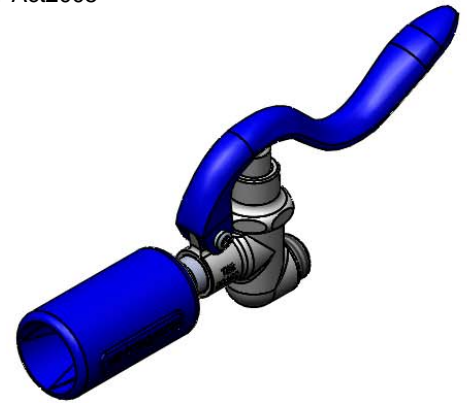

Features & Benefits:

- Designed for heavy-duty use in industrial kitchens
- 1.07 GPM spray valve
- Shuts off when handle is released
- Hold down ring
- 3/4-14 UN male inlet fitting
- Material: Polished chrome plated brass body and blue rubber bumper

Product Compliance:

- ASME A112.18.1 / CSA B125.1
- NSF 61 - Section 9
- NSF 372 (Low Lead Content)
- EPAAct 2005 (PRSV)
- EPA WaterSense (PRSV)



Warranty: One Year (Limited)

Performance Data:

- Pressure: 20 - 125 psi
- Temperature: 40 °F - 140 °F
- Flow Rate: 1.07 GPM @ 60 psi

