



Architect/Engineering Specifications:

Single hole single temperature deck mount faucet with polished chrome plated brass body, 5 5/8" rigid gooseneck with serrated tip outlet, compression cartridge, 4-arm handle and 1/2" NPSM male inlet. Certified to ASME A112.18.1 / CSA B125.1, NSF 61-Section 9 and NSF 372. Meets ADA ANSI/ICC A117.1 requirements.

Job Name _____

Model Specified _____ Quantity _____

Variations Specified _____

Date _____

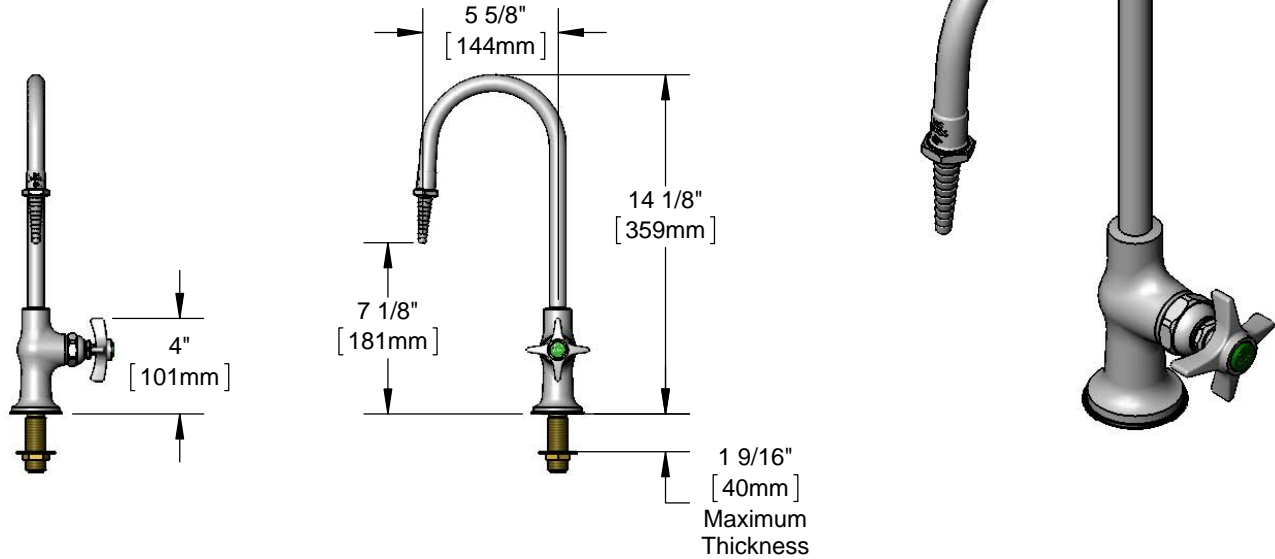

Features & Benefits:

- Single hole single temperature deck mount faucet w/ polished chrome plated brass body
- 5 5/8" rigid gooseneck
- Serrated tip outlet
- Eterna compression cartridge
- 4-arm handle w/ green index
- 1/2" NPSM male inlet
- Optional tailpiece and nut for 1/4" NPT male connection
- Material: Polished chrome plated brass body & tubular spout and handles

Product Compliance:

- ASME A112.18.1 / CSA B125.1
- NSF 61 - Section 9
- NSF 372 (Low Lead Content)
- ANSI A117.1 (ADA)

Warranty: One Year (Limited)

Performance Data:

- Pressure: 20 - 125 psi
- Temperature: 40 °F - 140 °F
- Flow Rate: 4.32 GPM @ 60 psi



ADA Compliant

Optional Handles

- 4" Wrist Action
- Lever
- 4-Arm (Standard)

Optional Cartridges

- Quarter-Turn Cerama
- Eterna (Standard)
- Quarter-Turn Eterna

