

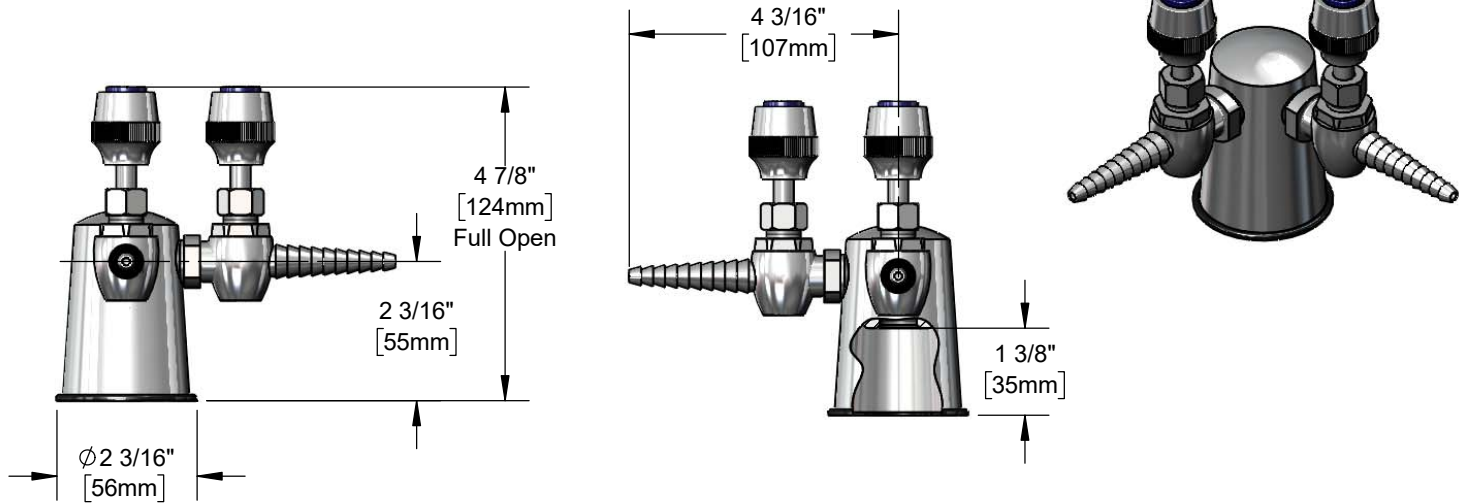

Architect/Engineering Specifications:

Laboratory turret with polished chrome plated brass body, (2) serrated tip outlets at 90 degrees and 3/8" NPT female inlet. Certified to ANSI Z21.15a / CSA 9.1a.

Job Name _____
 Model Specified _____ Quantity _____
 Variations Specified _____
 Date _____



Features & Benefits:

- Laboratory turret with polished chrome plated brass body
- (2) Serrated tip outlets at 90 degrees, fits 1/4" to 3/8" I.D. hoses
- Special packing in valve suitable for Oxygen, Hydrogen, and other special gases
- 3/8" NPT female inlet in base
- Black plastic base gasket
- Material: Polished chrome plated brass body

Product Compliance:

- ANSI Z21.15a / CSA 9.1a (Gas Valves)



Warranty: One Year (Limited)

Performance Data:

- Pressure:
 - Fuel Gas - 0.5 psi max
 - Other Gases Including Air - 80 psi max
 - Vacuum - 30 inches of Mercury max
- Temperature: 32°F - 125°F

