



Single Lever Faucets

B-2743

TAG:

Side Mount Faucet

Architect/Engineering Specifications:

Deck mounted single lever remote on/off control base faucet with polished chrome plated brass body, polished chrome plated brass deck mount swivel gooseneck, 2.2 GPM vandal resistant aerator, ceramic cartridge with adjustable temperature limit stop, single lever handle and 16" flexible stainless steel supply hoses with 3/8" compression connections, 4' sidespray with hose guide. Certified to ASME A112.18.1/CSA B125.1, NSF 61-Section 9 and NSF 372. Meets ADA ANSI/ICC A117.1 requirements.

Job Name _____
 Model Specified _____ Quantity _____
 Variations Specified _____
 Date _____

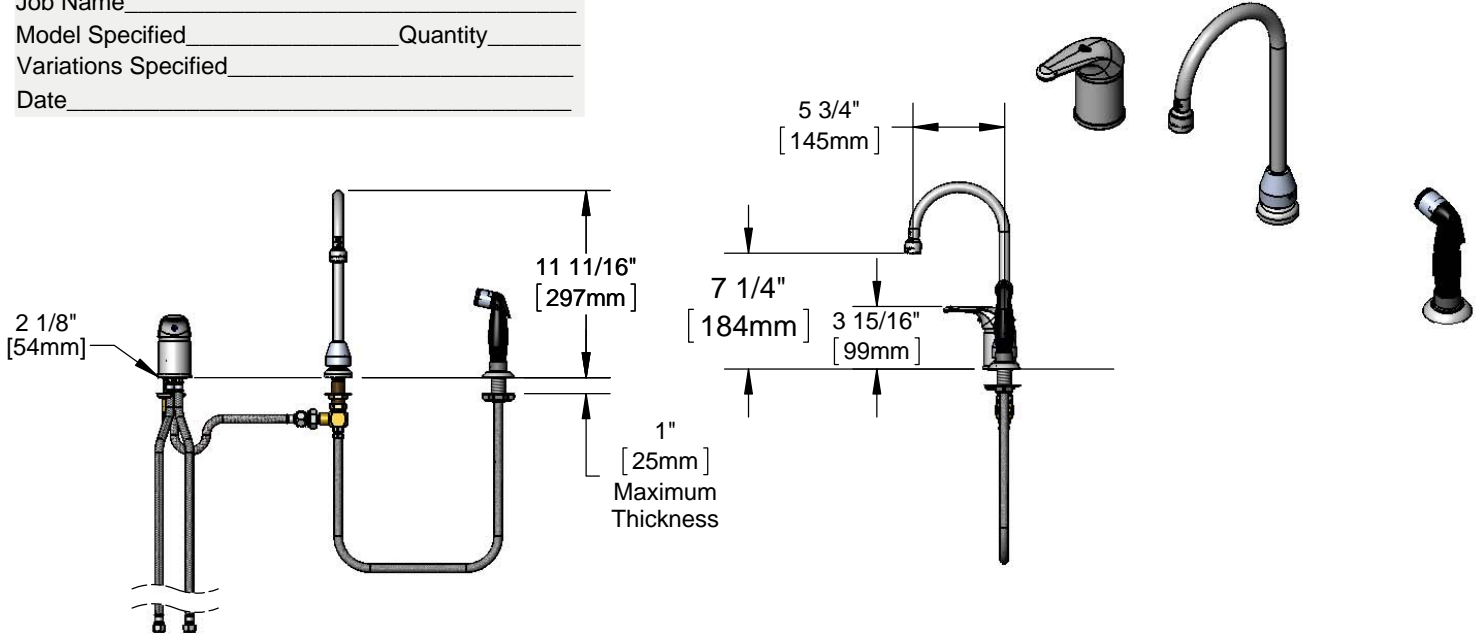

Features & Benefits:

- Deck mounted single lever remote on/off control base faucet w/ polished chrome plated brass body
- Polished chrome plated brass deck mount swivel gooseneck
- 2.2 GPM vandal resistant aerator, Series 6 (B-0199-06)
- Ceramic cartridge w/ adjustable temperature limit stop
- Single lever handle w/ color coded index
- 16" flexible stainless steel supply hoses w/ 3/8" O.D. compression connections
- 4' sidespray with hose guide
- Material: Polished chrome plated brass body, gooseneck & handle and stainless steel supply hoses

Product Compliance:

- ASME A112.18.1 / CSA B125.1
- NSF 61 - Section 9
- NSF 372 (Low Lead Content)
- ANSI A117.1 (ADA)



Warranty: One Year (Limited)

- Ceramic Cartridge: Two Year (Limited)

Performance Data:

- Pressure: 20 - 125 psi
- Temperature: 40 °F - 140 °F
- Flow Rate: 2.2 GPM @ 60 psi



ADA Compliant

Optional Outlets (Series 1 / VR Series 6)

GPM	Aerated	Non-Aerated (Laminar)	VR Aerated	VR Non-Aerated (VR Laminar)	Optional Handles
0.35	N/A	<input type="checkbox"/> B-0199-01-N035	N/A	<input type="checkbox"/> B-0199-06-N035	<input type="checkbox"/> 6" Long Handle
0.5	N/A	<input type="checkbox"/> B-0199-01-N05	N/A	<input type="checkbox"/> B-0199-06-N05	
1.0	<input type="checkbox"/> B-0199-01-F10	N/A	<input type="checkbox"/> B-0199-06-F10	N/A	
1.5	<input type="checkbox"/> B-0199-01-WS	<input type="checkbox"/> B-0199-29	<input type="checkbox"/> B-0199-06-WS	<input type="checkbox"/> B-0199-29VR	
2.2	<input type="checkbox"/> B-0199-01	<input type="checkbox"/> B-0199-21	Standard	<input type="checkbox"/> B-0199-21-VRF	



T&S BRASS AND BRONZE WORKS, INC.



• 2 Saddleback Cove • Travelers Rest, SC 29690
 Ph 800-476-4103 • Fax 864-834-3518
 • Simi Valley, CA • Ph 800-423-0150 • www.tsbrass.com

Date: 05/07/16