



Swivel Sink and Pantry Faucets

B-2484

TAG:

Double Pantry Faucet

Architect/Engineering Specifications:

8" wall mount mixing faucet with polished chrome plated brass body, 6" soap dish nozzle with garden hose male outlet, compression cartridges with spring checks, lever handles and 1/2" NPT male inlets. Certified to ASME A112.18.1/CSA B125.1, NSF 61-Section 9 and NSF 372. Meets ADA ANSI/ICC A117.1 requirements.

Job Name _____
 Model Specified _____ Quantity _____
 Variations Specified _____
 Date _____

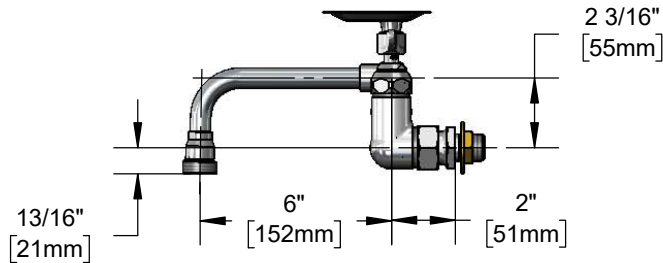
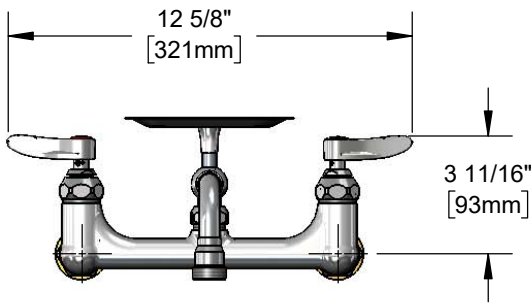

Features & Benefits:

- 8" wall mount mixing faucet with polished chrome plated brass body
- 6" soap dish nozzle w/ garden hose outlet
- Lock washer provided for rigid application
- Quarter-turn Eterna compression cartridges w/ spring checks to prevent cross flow of water
- Lever handles w/ color coded indexes
- 1/2" NPT male inlets w/ 1 5/16" hex flanges
- Material: Polished chrome plated brass body & tubular spout and chrome plated metal handles

Product Compliance:

- ASME A112.18.1 / CSA B125.1
- NSF 61 - Section 9
- NSF 372 (Low Lead Content)
- ANSI A117.1 (ADA)



Warranty: One Year (Limited)

Performance Data:

- Pressure: 20 - 125 psi
- Temperature: 40 °F - 140 °F
- Flow Rate: 16.84 GPM @ 60 psi



Optional Handles

- 4" Wrist Action
- Lever (Standard)
- 4-Arm

Optional Cartridges With Checks

- Quarter-Turn Cerama w/ Check Valve
- Quarter-Turn Eterna w/ Spring Check (Standard)



T&S BRASS AND BRONZE WORKS, INC.



• 2 Saddleback Cove • Travelers Rest, SC 29690
 Ph 800-476-4103 • Fax 864-834-3518
 • Simi Valley, CA • Ph 800-423-0150 • www.tsbrass.com

Date: 01/22/18