



Architect/Engineering Specifications:

8" wall mount mixing faucet with chrome plated brass body, 5" riser, swivel tee with continuous pressure vacuum breakers, 144" flexible stainless steel hoses with heat resistant handles, high flow angled spray valve, spray valve with hook nozzle, compression cartridges with spring checks, lever handles and wall hooks. Certified to ASME A112.18.1/CSA B125.1, NSF 61-Section 9 and NSF 372.

Job Name _____

Model Specified _____ Quantity _____

Variations Specified _____

Date _____

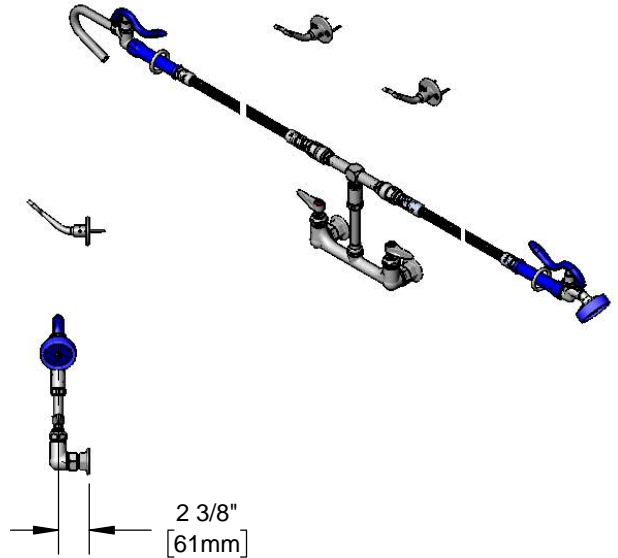
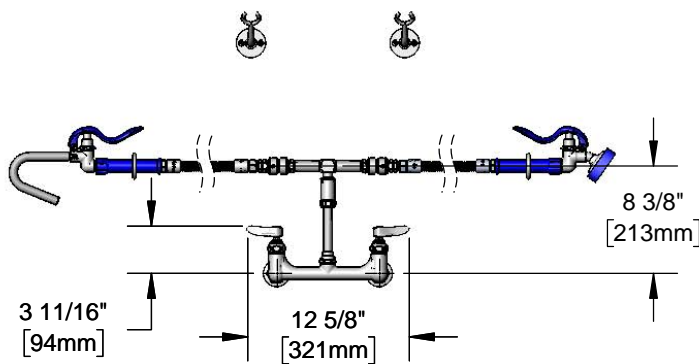

Features & Benefits:

- 8" wall mount mixing faucet w/ polished chrome plated brass body
- Swivel tee w/ 5" EasyInstall riser
- Continuous pressure vacuum breakers
- 144" flexible stainless steel hoses with heat resistant blue handles and hold down rings
- High flow spray valve
- Spray valve with hook nozzle
- Quarter-turn Eterna compression cartridges w/ spring checks to prevent cross flow of water
- Lever handles w/ color coded indexes
- Two wall hooks w/ mounting screws
- Material: Polished chrome plated brass body, riser, swivel tee and spray valve bodies, chrome plated vacuum breakers, chrome plated metal handles and stainless steel hose

Product Compliance:

- ASME A112.18.1 / CSA B125.1
- NSF 61 - Section 9
- NSF 372 (Low Lead Content)
- EPA Act 2005 Non-Compliant (PRSV)
- CSA B64.8 (VB)



Warranty: One Year (Limited)

Performance Data:

- Pressure: 20 - 125 psi
- Temperature: 40 °F - 140 °F
- Flow Rate:
 - Spray Valve: 2.68 GPM @ 60 psi
 - Hook Nozzle: 3.16 GPM @ 60 psi

Optional Handles

- 4" Wrist Action
- Lever (Standard)
- 4-Arm

Optional Pre-Rinse Spray Valves

- B-0107 (1.42 GPM)
- B-0107-C (0.65 GPM)
- B-0107-J (1.07 GPM)
- B-0108 (1.48 GPM)
- B-0108-C (0.65 GPM)

Optional Cartridges With Checks

- Quarter-Turn Cerama w/ Check Valve
- Quarter-Turn Eterna w/ Spring Check (Standard)

