



Dipperwell Faucets

B-2282-F15

TAG:

Dipperwell Faucet

Architect/Engineering Specifications:

Dipperwell faucet with polished chrome plated brass body with 1.4 GPM flow control tower, spout, polished chrome plated knob and 1/2" NPSM male inlet with 5/16" I.D. sweat fitting connection. Certified to ASME A112.18.1/CSA B125.1, NSF 61-Section 9 and NSF 372.

Job Name _____
 Model Specified _____ Quantity _____
 Variations Specified _____
 Date _____

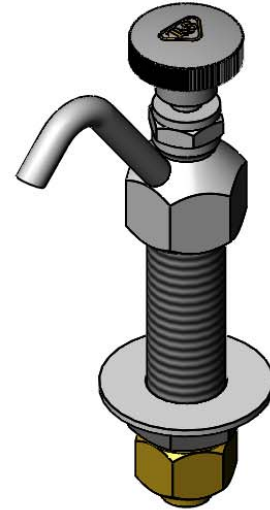
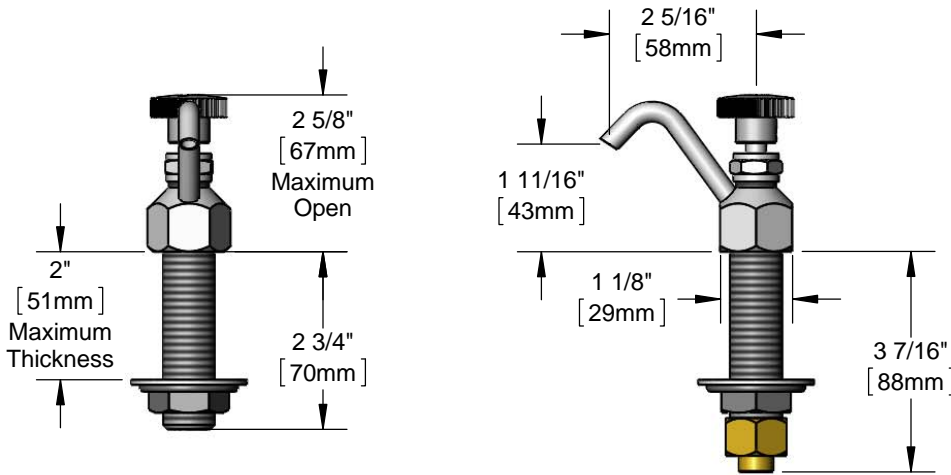

Features & Benefits:

- Dipperwell faucet with polished chrome plated brass body with spout
- 1.4 GPM flow control tower
- Polished chrome plated brass knob
- 1/2" NPSM male inlet with 5/16" I.D. sweat fitting connection
- Material: Polished chrome plated brass body, tubular spout & knob

Product Compliance:

- ASME A112.18.1 / CSA B125.1
- NSF 61 - Section 9
- NSF 372 (Low Lead Content)



Warranty: One Year (Limited)

Performance Data:

- Pressure: 20 - 125 psi
- Temperature: 40°F - 140°F
- Flow Rate: 1.4 GPM @ 60 psi



T&S BRASS AND BRONZE WORKS, INC.



• 2 Saddleback Cove • Travelers Rest, SC 29690
 Ph 800-476-4103 • Fax 864-834-3518
 • Simi Valley, CA • Ph 800-423-0150 • www.tsbrass.com

Date: 09/30/16