

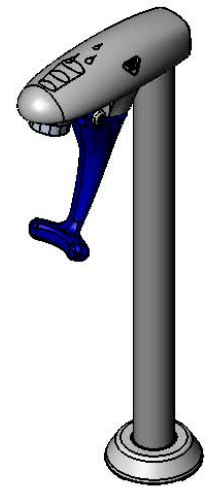

Architect/Engineering Specifications:

8" high deck mount glass filler with polished chrome plated brass body, adjustable flow outlet, push back actuation arm, pedestal with adjustable deck flange, water filtration cartridge and 1/2" NPT male inlet. Certified to ASME A112.18.1/CSA B125.1, NSF 61-Section 9 and NSF 372. Meets ADA ANSI/ICC A117.1 requirements.

Job Name _____
 Model Specified _____ Quantity _____
 Variations Specified _____
 Date _____

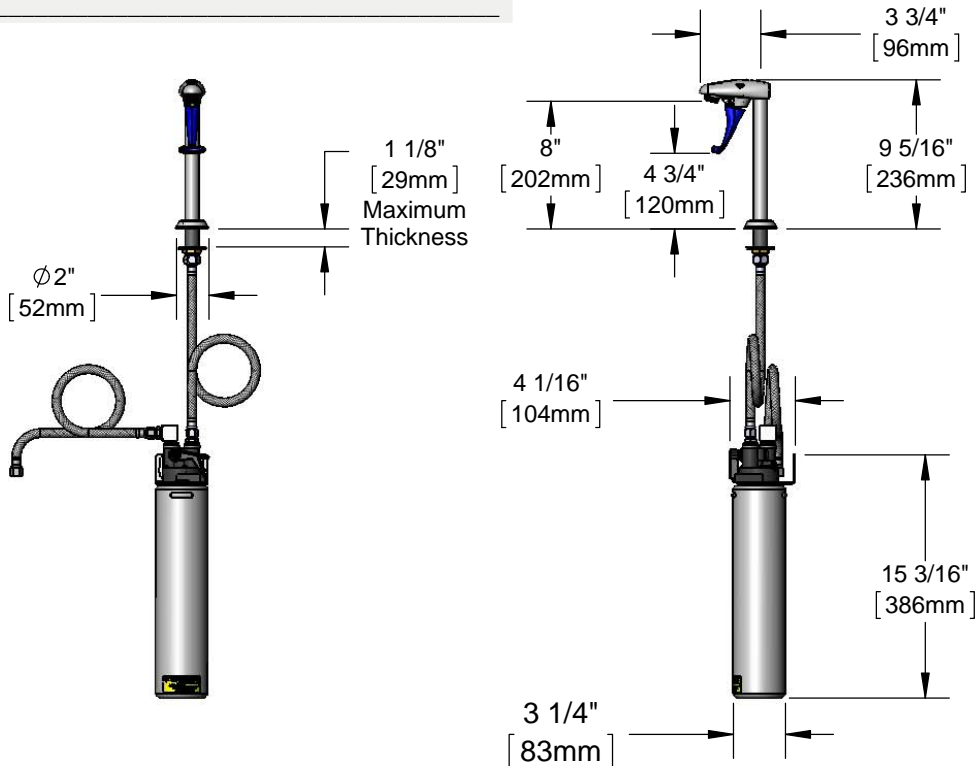

Features & Benefits:

- 8" high deck mount glass filler
- Torx wrench adjustable flow outlet (wrench included)
- Dark blue push back arm
- Instantaneous shut-off
- 1/2" NPT male inlet
- Pedestal w/ adjustable \varnothing 2" flange
- Replacement water filtration cartridge & docking station
- Material: polished chrome plated brass body & pedestal, chrome plated metal flange and thermoplastic arm

Product Compliance:

- ASME A112.18.1 / CSA B125.1
- NSF 61 - Section 9
- NSF 372 (Low Lead Content)
- ANSI A117.1 (ADA)

Warranty: One Year (Limited)

Performance Data:

- Pressure: 20 - 125 psi
- Temperature: 40°F - 140°F
- Flow Rate: 0.25 GPM min @ 60 psi
2.25 GPM max @ 60 psi



ADA Compliant

