



Architect/Engineering Specifications:

8" deck mount mixing faucet with chrome plated brass body, 6" swing nozzle with 2.2 GPM aerator, compression cartridges with spring checks, lever handles, 1/2" NPSM extended male inlets and chrome plated escutcheon. Certified to ASME A112.18.1/CSA B125.1, NSF 61-Section 9 and NSF 372. Meets ADA ANSI/ICC A117.1 requirements.

Job Name _____

Model Specified _____ Quantity _____

Variations Specified _____

Date _____

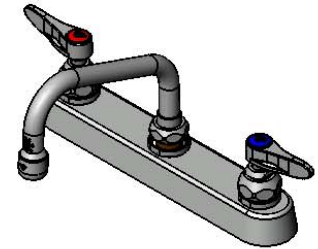
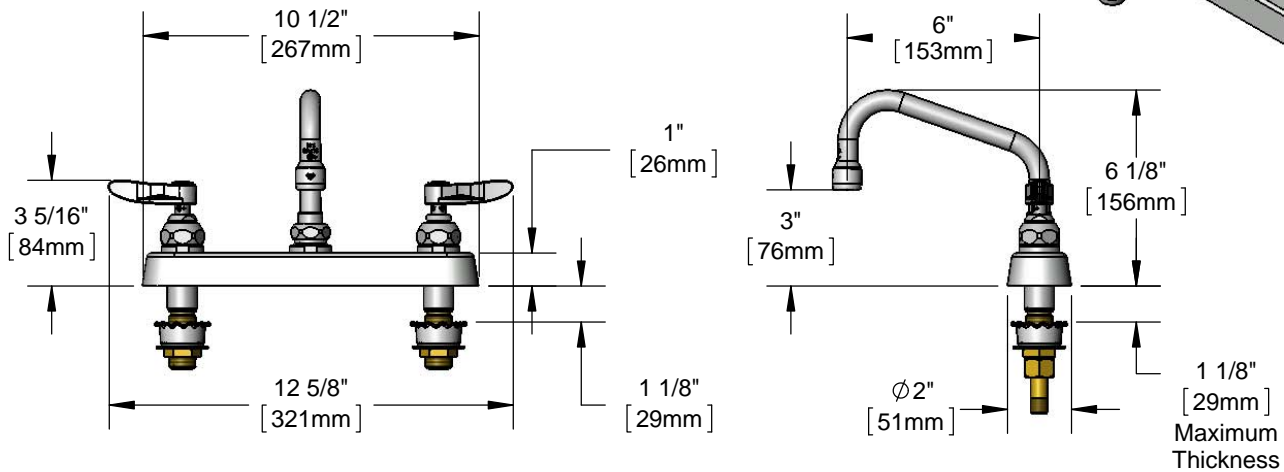

Features & Benefits:

- 8" deck mount mixing faucet w/ chrome plated brass body
- 6" swing nozzle
- 2.2 GPM aerator, Series 1 (B-0199-01)
- Quarter-turn Eterna compression cartridges with spring checks to prevent cross flow of water
- Lever handles w/ color coded indexes
- 1/2" NPSM extended male inlets
- Tailpieces and nuts for 1/4" NPT male connections
- Chrome plated escutcheon
- Material: Chrome plated brass body & tubular spout and chrome plated metal handles & escutcheon

Product Compliance:

- ASME A112.18.1 / CSA B125.1
- NSF 61 - Section 9
- NSF 372 (Low Lead Content)
- ANSI A117.1 (ADA)



Warranty: One Year (Limited)

Performance Data:

- Pressure: 20 - 125 psi
- Temperature: 40 °F - 140 °F
- Flow Rate: 2.2 GPM @ 60 psi



ADA Compliant

Optional Outlets (Series 1 / VR Series 6)

GPM	Aerated	Non-Aerated (Laminar)	VR Aerated	VR Non-Aerated (VR Laminar)
0.35	N/A	<input type="checkbox"/> B-0199-01-N035	N/A	<input type="checkbox"/> B-0199-06-N035
0.5	N/A	<input type="checkbox"/> B-0199-01-N05	N/A	<input type="checkbox"/> B-0199-06-N05
1.0	<input type="checkbox"/> B-0199-01-F10	N/A	<input type="checkbox"/> B-0199-06-F10	N/A
1.5	<input type="checkbox"/> B-0199-01-WS	<input type="checkbox"/> B-0199-29	<input type="checkbox"/> B-0199-06-WS	<input type="checkbox"/> B-0199-29VR
2.2	Standard	<input type="checkbox"/> B-0199-21	<input type="checkbox"/> B-0199-06	<input type="checkbox"/> B-0199-21-VRF

Optional Handles

- 4" Wrist Action
- Lever (Standard)

Optional Cartridges

- Quarter-Turn Cerama w/ Check Valve
- Quarter-Turn Eterna w/ Spring Check (Standard)

