



Service Sink / Mop Sink Faucets

B-0674-CR-BSTP

TAG:

Service Sink Faucet

Architect/Engineering Specifications:

8" wall mount mixing faucet with polished chrome plated brass body, polished chrome plated brass spout with vacuum breaker, pail hook and garden hose male outlet, ceramic cartridges with check valves, lever handles, 1/2" NPT female inlets and built-in service stops in body. Certified to ASME A112.18.1/CSA B125.1, NSF 61-Section 9, NSF 372 and ASSE 1001. Meets ADA ANSI/ICC A117.1 requirements.

Job Name _____

Model Specified _____ Quantity _____

Variations Specified _____

Date _____

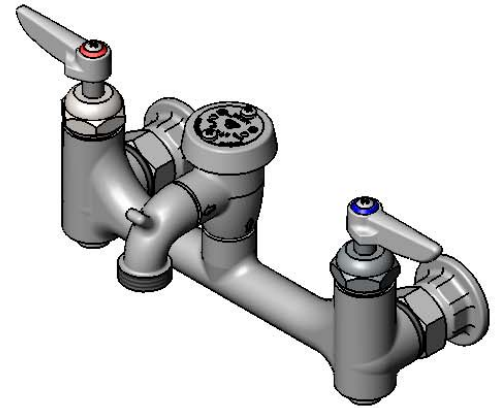
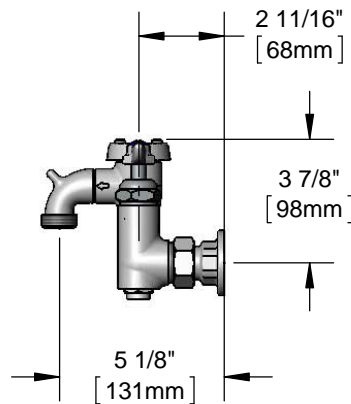
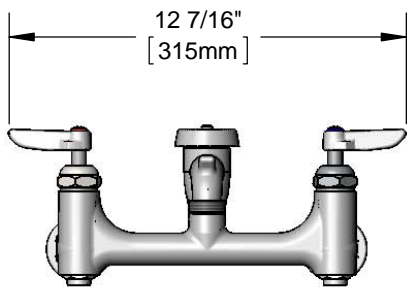

Features & Benefits:

- 8" wall mount mixing faucet with polished chrome plated brass body
- Vacuum breaker spout with pail hook & garden hose male outlet
- Lever handles with color coded indexes
- Quarter-turn Cerama cartridges with check valves to prevent cross flow of water
- 1/2" NPT female eccentric inlets with Ø2" flanges
- Adjustable centers from 7 3/4" to 8 1/4"
- Built-in service stops in body
- Material: polished chrome plated brass body, spout & inlets and chrome plated metal handles

Product Compliance:

- ASME A112.18.1 / CSA B125.1
- NSF 61 - Section 9
- NSF 372 (Low Lead Content)
- ANSI A117.1 (ADA)
- ASSE 1001 (VB)

Warranty: One Year (Limited)

- Cerama Cartridge : Lifetime (Limited)

Performance Data:

- Pressure: 20 - 125 psi
- Temperature: 40 °F - 180 °F
- Flow Rate: 10.40 GPM @ 60 psi



ADA Compliant



Optional Handles

- 4" Wrist Action
- Lever (Standard)
- 4-Arm

Optional Cartridges With Checks

- Quarter-Turn Cerama w/ Check Valve (Standard)
- Quarter-Turn Eterna w/ Spring Check



T&S BRASS AND BRONZE WORKS, INC.



• 2 Saddleback Cove • Travelers Rest, SC 29690
 Ph 800-476-4103 • Fax 864-834-3518
 • Simi Valley, CA • Ph 800-423-0150 • www.tsbrass.com

Date: 08/24/16