



# Service Sink / Mop Sink Faucets

## B-0656-POL

TAG:

## Service Sink Faucet

### Architect/Engineering Specifications:

8" wall mount mixing faucet with polished chrome plated brass body, polished chrome plated brass spout with pail hook and garden hose male outlet, compression cartridges with spring checks, lever handles, 1/2" NPT female inlets, loose key stops, 1 3/4" wall extensions and lower support rod. Certified to ASME A112.18.1/CSA B125.1, NSF 61-Section 9, NSF 372 and ASSE 1001. Meets ADA ANSI/ICC A117.1 requirements.

Job Name \_\_\_\_\_  
 Model Specified \_\_\_\_\_ Quantity \_\_\_\_\_  
 Variations Specified \_\_\_\_\_  
 Date \_\_\_\_\_

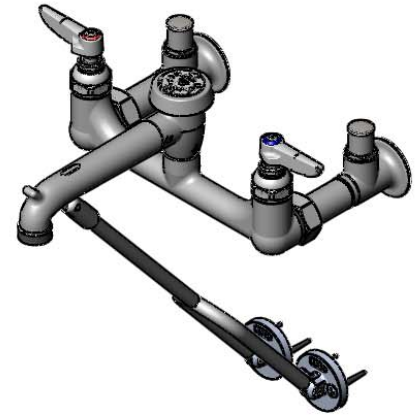
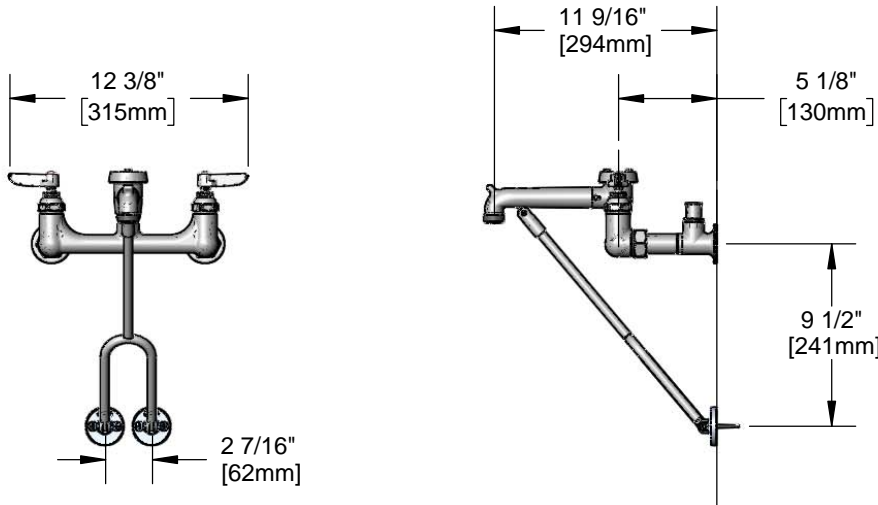

### Features & Benefits:

- 8" wall mount mixing faucet with polished chrome plated brass body
- Spout with pail hook & garden hose male outlet
- Lever handles with color coded indexes
- Quarter-turn Eterna compression cartridges with spring checks to prevent cross flow of water
- 1/2" NPT female extension inlets w/ Ø 2" flanged loose key stops
- Inlet extensions allow 5 1/8" from wall to center of faucet
- Lower rod support
- Material: Polished chrome plated brass body & spout and chrome plated metal handles

### Product Compliance:

- ASME A112.18.1 / CSA B125.1
- NSF 61 - Section 9
- NSF 372 (Low Lead Content)
- ASSE 1001 (VB)
- ANSI A117.1 (ADA)

**Warranty:** One Year (Limited)

### Performance Data:

- Pressure: 20 - 125 psi
- Temperature: 40 °F - 140 °F
- Flow Rate: 8.90 GPM @ 60 psi



ADA Compliant



### Optional Handles

- 4" Wrist Action
- Lever (Standard)
- 4-Arm

### Optional Cartridges With Checks

- Quarter-Turn Cerama w/ Check Valve
- Quarter-Turn Eterna w/ Spring Check (Standard)



T&S BRASS AND BRONZE WORKS, INC.



• 2 Saddleback Cove • Travelers Rest, SC 29690  
 Ph 800-476-4103 • Fax 864-834-3518  
 • Simi Valley, CA • Ph 800-423-0150 • www.tsbrass.com

Date: 10/30/17