



Rigid and Swivel Gooseneck Spouts

B-0545-F12

TAG:

Swivel Gooseneck Spout

Architect/Engineering Specifications:

Deck mount swivel gooseneck with polished chrome plated brass deck flange and gooseneck, 1.2 GPM flow control in shank and 1/2" NPSM male inlet. Certified to ASME A112.18.1/CSA B125.1, NSF 61-Section 9 and NSF 372.

Job Name _____
 Model Specified _____ Quantity _____
 Variations Specified _____
 Date _____

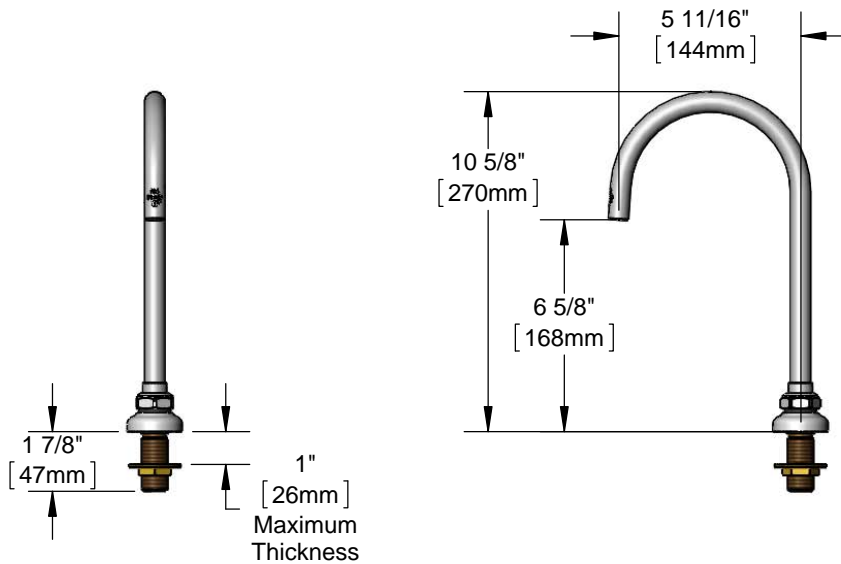

Features & Benefits:

- Deck mount swivel dummy gooseneck for remote locations
- 5 11/16" plain end swivel gooseneck
- 1.2 GPM flow control in shank
- 1/2" NPSM male inlet w/ \varnothing 2" flange
- Tailpiece and nut for 1/4" NPT male connection
- Material: Polished chrome plated brass flange & tubular spout

Product Compliance:

- ASME A112.18.1 / CSA B125.1
- NSF 61 - Section 9
- NSF 372 (Low Lead Content)

Warranty: One Year (Limited)

Performance Data:

- Pressure: 20 - 125 psi
- Temperature: 40 °F - 140 °F
- Flow Rate: 1.2 GPM @ 60 psi



T&S BRASS AND BRONZE WORKS, INC.



• 2 Saddleback Cove • Travelers Rest, SC 29690
 Ph 800-476-4103 • Fax 864-834-3518
 • Simi Valley, CA • Ph 800-423-0150 • www.tsbrass.com

Date: 07/23/16