



Rigid And Swivel Gooseneck Spouts

B-0523

TAG:

Rigid Dummy Spout

Architect/Engineering Specifications:

Deck mount rigid dummy gooseneck with polished chrome plated brass deck flange and gooseneck, 2.2 GPM aerator outlet and 1/2" NPSM male inlet. Certified to ASME A112.18.1/CSA B125.1, NSF 61-Section 9 and NSF 372.

Job Name _____
 Model Specified _____ Quantity _____
 Variations Specified _____
 Date _____

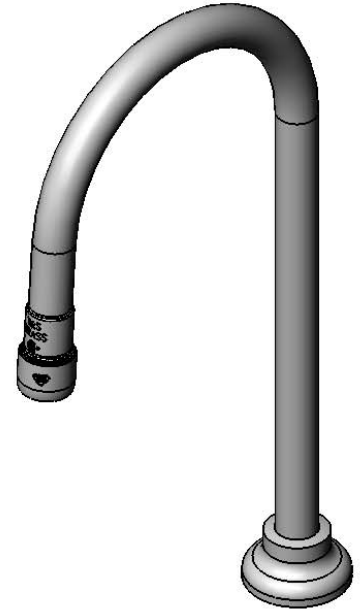
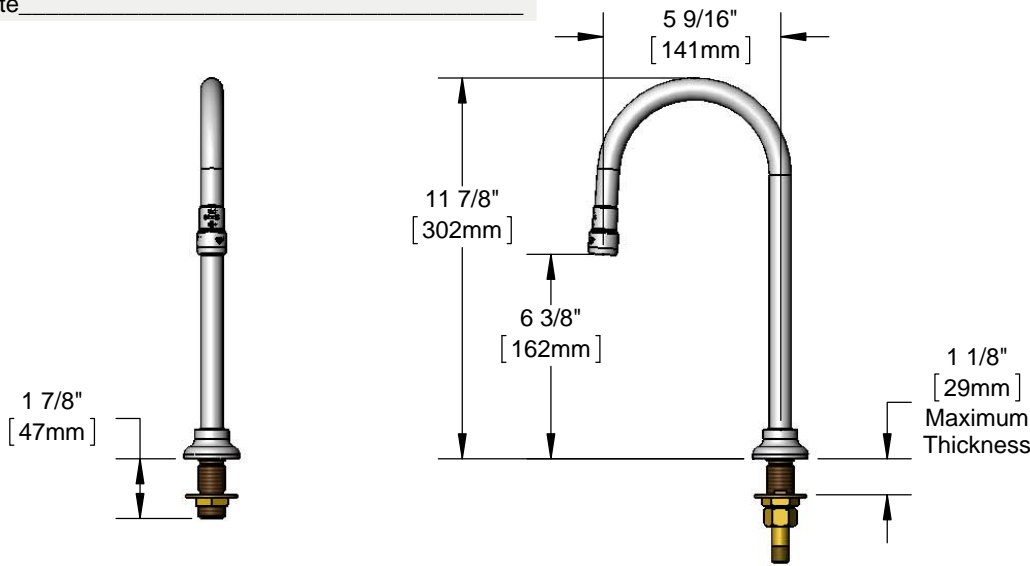

Features & Benefits:

- Deck mounted rigid dummy gooseneck for remote locations
- 2.2 GPM aerator outlet, Series 2
- 1/2" NPSM male inlet
- Tailpiece and nut for 1/4" NPT male connection
- Material: Polished chrome plated brass flange & tubular spout

Product Compliance:

- ASME A112.18.1 / CSA B125.1
- NSF 61 - Section 9
- NSF 372 (Low Lead Content)



Warranty: One Year (Limited)



Performance Data:

- Pressure: 20 - 125 psi
- Temperature: 40 °F - 140 °F
- Flow Rate: 2.2 GPM @ 60 psi

Optional Outlets (Series 2 / VR Series 7)

GPM	Aerated	Non-Aerated (Laminar)	VR Aerated	VR Non-Aerated (VR Laminar)
0.35	N/A	<input type="checkbox"/> B-0199-02-N035	N/A	<input type="checkbox"/> B-0199-07-N035
0.5	N/A	<input type="checkbox"/> B-0199-02-N05	N/A	<input type="checkbox"/> B-0199-07-N05
1.0	<input type="checkbox"/> B-0199-02-F10	N/A	<input type="checkbox"/> B-0199-07-F10	N/A
1.5	<input type="checkbox"/> B-0199-02-WS	N/A	<input type="checkbox"/> B-0199-07-WS	N/A
2.2	Standard	N/A	<input type="checkbox"/> B-0199-07	N/A



T&S BRASS AND BRONZE WORKS, INC.



• 2 Saddleback Cove • Travelers Rest, SC 29690
 Ph 800-476-4103 • Fax 864-834-3518
 • Simi Valley, CA • Ph 800-423-0150 • www.tsbrass.com

Date: 07/23/16