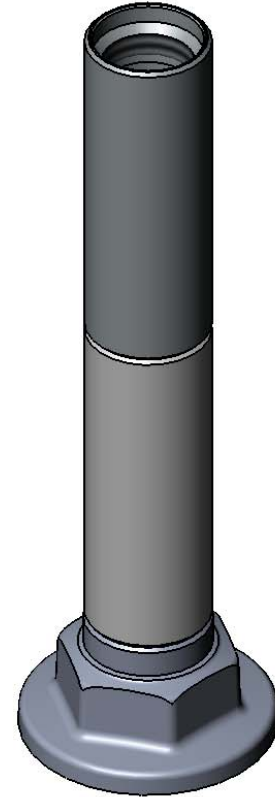
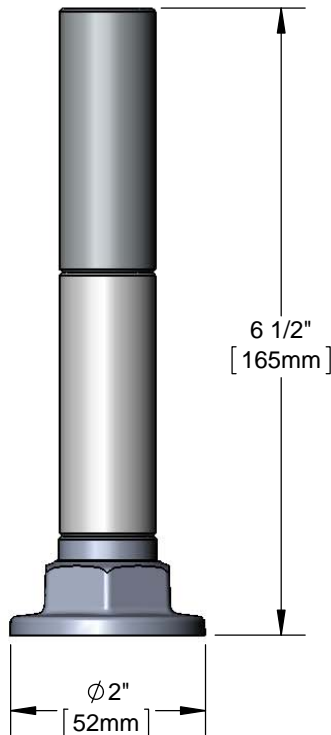

**Architect/Engineering Specifications:**

6 1/2" faucet inlet extension with 1/2" NPT female inlet and outlet, used to extend faucets with 1/2" NPT male inlets. Certified to ASME A112.18.1/CSA B125.1, NSF 61-Section 9 and NSF 372.

Job Name \_\_\_\_\_  
 Model Specified \_\_\_\_\_ Quantity \_\_\_\_\_  
 Variations Specified \_\_\_\_\_  
 Date \_\_\_\_\_

**Features & Benefits:**

- 6 1/2" faucet inlet extension
- 1/2" NPT female inlet and outlet
- Used to extend faucets with 1/2" NPT male inlets
- Material: Polished chrome plated brass

**Product Compliance:**

- ASME A112.18.1 / CSA B125.1
- NSF 61 - Section 9
- NSF 372 (Low Lead Content)



**Warranty:** One Year (Limited)

**Performance Data:**

- N/A

