

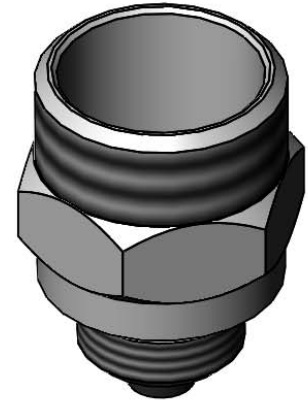

Architect/Engineering Specifications:

Rigid to swivel adapter, polished chrome plated brass body with 1.4 GPM flow control, 1-20 UN male swivel outlet and 3/8" NPT male inlet. Certified to ASME A112.18.1/CSA B125.1, NSF 61-Section 9 and NSF 372.

Job Name _____
 Model Specified _____ Quantity _____
 Variations Specified _____
 Date _____

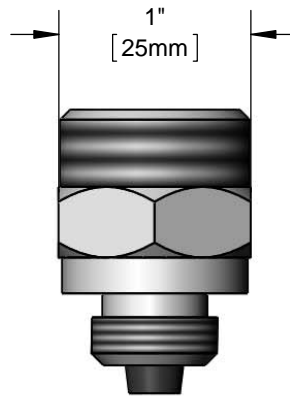
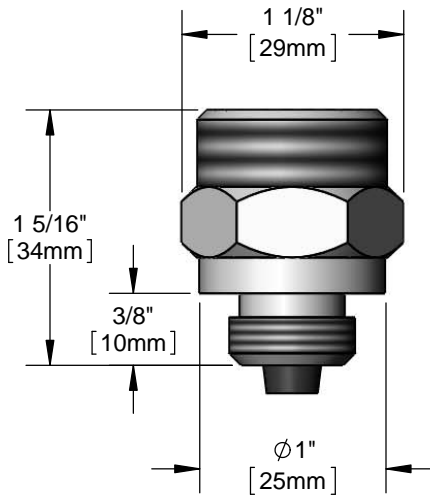

Features & Benefits:

- Rigid to swivel polished chrome plated brass adapter
- 1.4 GPM flow control
- 1-20 UN male swivel outlet accepts standard T&S swing nozzles
- 3/8" NPT male inlet
- Material: Polished chrome plated brass body

Product Compliance:

- ASME A112.18.1 / CSA B125.1
- NSF 61 - Section 9
- NSF 372 (Low Lead Content)

Warranty: One Year (Limited)

Performance Data:

- Pressure: 20 - 125 psi
- Temperature: 40 °F - 140 °F
- Flow Rate: 1.4 GPM @ 60 psi

