



Service Sink / Mop Sink Faucets

B-0362

TAG:

Service Sink Faucet

Architect/Engineering Specifications:

8" wall mount mixing faucet with polished chrome plated brass body, polished chrome plated brass spout with pail hook and garden hose outlet, compression cartridges with spring checks, 6" wrist action handles, 1/2" NPT female inlets, loose key stops, 1 3/4" wall extensions and lower support rod. Certified to ASME A112.18.1/CSA B125.1, NSF 61-Section 9 and NSF 372. Meets ADA ANSI/ICC A117.1 requirements.

Job Name _____
 Model Specified _____ Quantity _____
 Variations Specified _____
 Date _____

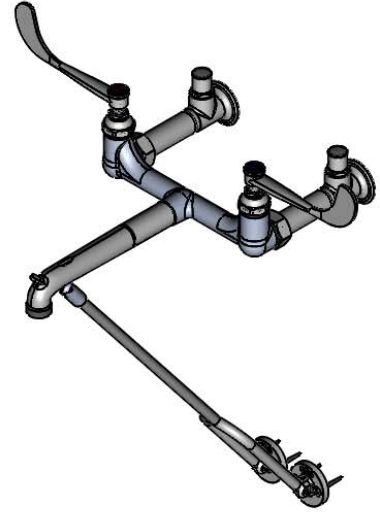
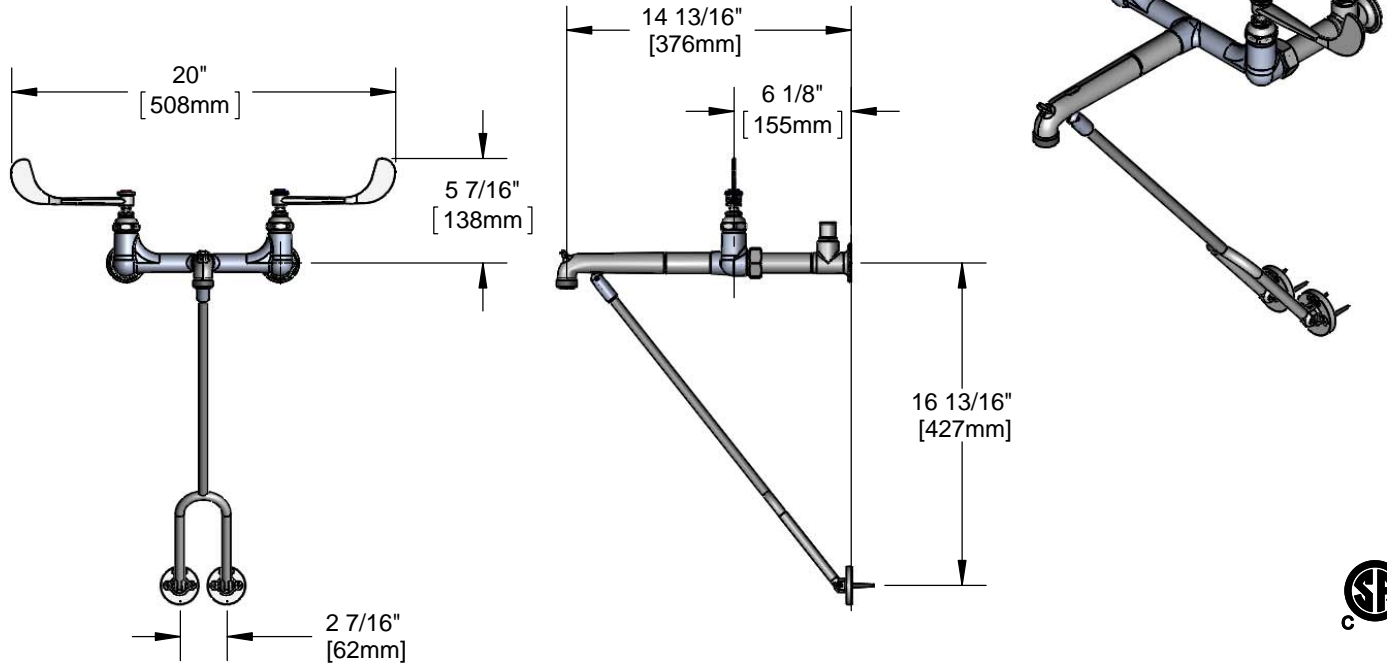

Features & Benefits:

- 8" wall mount mixing faucet with polished chrome plated brass body
- Spout with pail hook & garden house outlet
- 6" wrist action handles with color coded indexes
- Quarter-turn Eterna compression cartridges with spring checks to prevent cross flow of water
- 1/2" NPT female extension inlets w/ Ø 2" flanged loose key stops
- Inlet extensions allow 6 1/8" from wall to center of faucet
- Lower rod support
- Material: Polished chrome plated brass body, spout and handles

Product Compliance:

- ASME A112.18.1 / CSA B125.1
- NSF 61 - Section 9
- NSF 372 (Low Lead Content)
- ANSI A117.1 (ADA)

Warranty: One Year (Limited)

Performance Data:

- Pressure: 20 - 125 psi
- Temperature: 40 °F - 140 °F
- Flow Rate: 10.22 GPM @ 60 psi



ADA Compliant

Optional Handles

- 4" Wrist Action
- Lever
- 4-Arm

Optional Cartridges With Checks

- Quarter-Turn Cerama w/ Check Valve
- Quarter-Turn Eterna w/ Spring Check (Standard)



T&S BRASS AND BRONZE WORKS, INC.



• 2 Saddleback Cove • Travelers Rest, SC 29690
 Ph 800-476-4103 • Fax 864-834-3518
 • Simi Valley, CA • Ph 800-423-0150 • www.tsbrass.com

Date: 06/22/16