



# Swivel Sink and Pantry Faucets

TAG:

## B-0325-LN

### Deck Mixing Faucet

#### Architect/Engineering Specifications:

4" deck mount mixing faucet with polished chrome plated brass body, swivel outlet (less nozzle), compression cartridges, lever handles and 1/2" NPT female inlets. Certified to ASME A112.18.1/CSA B125.1, NSF 61-Section 9 and NSF 372. Meets ADA ANSI/ICC A117.1 requirements.

Job Name \_\_\_\_\_  
 Model Specified \_\_\_\_\_ Quantity \_\_\_\_\_  
 Variations Specified \_\_\_\_\_  
 Date \_\_\_\_\_

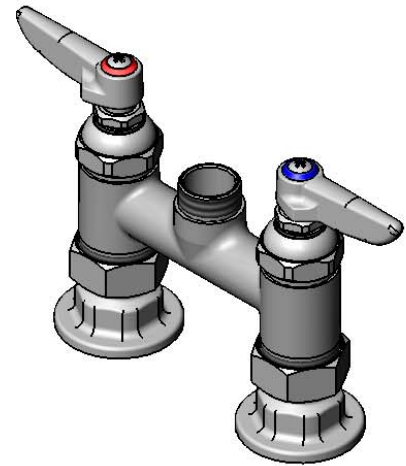
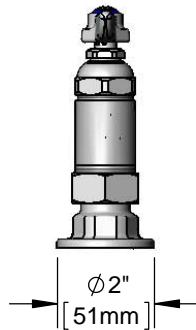
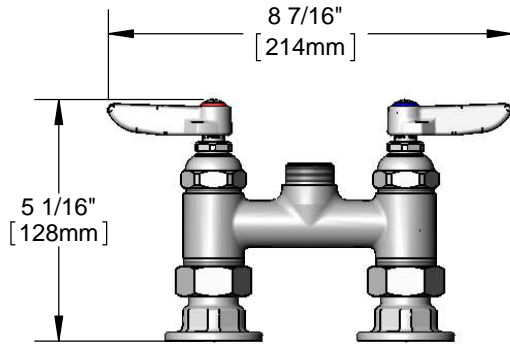

#### Features & Benefits:

- 4" deck mount mixing faucet with polished chrome plated brass body
- Swivel outlet accepts T&S swing nozzles
- Eterna compression cartridges
- Lever handle w/ color coded indexes
- 1/2" NPT female eccentric inlets w/ Ø 2" flanges
- Adjustable centers from 3 3/4" to 4 1/4"
- Material: Polished chrome plated brass body and polished chrome plated metal handles

#### Product Compliance:

- ASME A112.18.1 / CSA B125.1
- NSF 61 - Section 9
- NSF 372 (Low Lead Content)
- ANSI A117.1 (ADA)



ADA Compliant

**Warranty:** One Year (Limited)

#### Performance Data:

- Pressure: 20 - 125 psi
- Temperature: 40 °F - 140 °F
- Flow Rate: 26.27 GPM @ 60 psi  
(Outlet Device &/or Final Configuration May Reduce Flow Rate)

#### T&S Swing Nozzles

- 059X 6" Swing Nozzle
- 060X 8" Swing Nozzle
- 061X 10" Swing Nozzle
- 062X 12" Swing Nozzle
- 063X 14" Swing Nozzle
- 064X 16" Swing Nozzle
- 065X 18" Swing Nozzle
- 066X 12" Double Joint Swing Nozzle
- 067X 15" Double Joint Swing Nozzle
- 068X 18" Double Joint Swing Nozzle
- 069X 24" Double Joint Swing Nozzle

#### Optional Outlets (Series 1 / VR Series 6)

| GPM  | Aerated                                | Non-Aerated (Laminar)                   | VR Aerated                             | VR Non-Aerated (VR Laminar)             |
|------|--|---|--|---|
| 0.35 | N/A                                    | <input type="checkbox"/> B-0199-01-N035 | N/A                                    | <input type="checkbox"/> B-0199-06-N035 |
| 0.5  | N/A                                    | <input type="checkbox"/> B-0199-01-N05  | N/A                                    | <input type="checkbox"/> B-0199-06-N05  |
| 1.0  | <input type="checkbox"/> B-0199-01-F10 | N/A                                     | <input type="checkbox"/> B-0199-06-F10 | N/A                                     |
| 1.5  | <input type="checkbox"/> B-0199-01-WS  | <input type="checkbox"/> B-0199-29      | <input type="checkbox"/> B-0199-06-WS  | <input type="checkbox"/> B-0199-29VR    |
| 2.2  | <input type="checkbox"/> B-0199-01     | <input type="checkbox"/> B-0199-21      | <input type="checkbox"/> B-0199-06     | <input type="checkbox"/> B-0199-21-VRF  |

#### T&S Swivel Goosenecks (D x K)

- 131X 2 13/16" x 2 9/16" Swivel Gooseneck
- 132X 2 5/8" x 5 7/16" Swivel Gooseneck
- 133X 5 11/16" x 6 1/4" Swivel Gooseneck
- 135X 8 3/4" x 5 5/8" Swivel Gooseneck

#### Optional Handles

- 4" Wrist Action
- Lever (Standard)
- 4-Arm

#### Optional Cartridges

- Quarter-Turn Cerama
- Eterna (Standard)
- Quarter-Turn Eterna



T&S BRASS AND BRONZE WORKS, INC.



• 2 Saddleback Cove • Travelers Rest, SC 29690  
 Ph 800-476-4103 • Fax 864-834-3518  
 • Simi Valley, CA • Ph 800-423-0150 • www.tsbrass.com

Date: 06/22/16