



Swivel Sink and Pantry Faucets

B-0205-061X-CR

TAG:

Single Pantry Faucet

Architect/Engineering Specifications:

Single hole single temperature deck mount faucet with polished chrome plated brass body, 10" swing nozzle with stream regulator outlet, ceramic cartridge, lever handle and 1/2" NPSM male inlet. Certified to ASME A112.18.1/CSA B125.1, NSF 61-Section 9 and NSF 372. Meets ADA ANSI/ICC A117.1 requirements.

Job Name _____
 Model Specified _____ Quantity _____
 Variations Specified _____
 Date _____

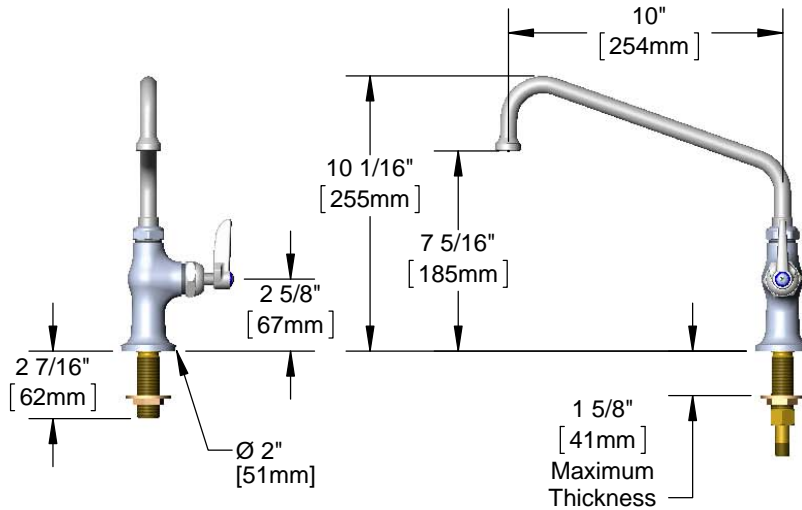

Features & Benefits:

- Single hole single temperature deck mount faucet w/ polished chrome plated brass body
- 10" swing nozzle
- Stream regulator outlet, Series 1
- Quarter-turn Cerama cartridge
- Lever handle w/ color coded index
- $\phi 2"$ flange w/ 1/2" NPSM male inlet
- Tailpiece and nut to provide 1/4" NPT male connection
- Material: Polished chrome plated brass body & tubular spout and polished chrome plated metal handle

Product Compliance:

- ASME A112.18.1 / CSA B125.1
- NSF 61 - Section 9
- NSF 372 (Low Lead Content)
- ANSI A117.1 (ADA)



Warranty: One Year (Limited)

- Cerama Cartridge: Lifetime (Limited)

Performance Data:

- Pressure: 20 - 125 psi
- Temperature: 40°F - 180°F
- Flow Rate: 4.55 GPM @ 60 psi



Optional Outlets (Series 1 / VR Series 6)

GPM	Aerated	Non-Aerated (Laminar)	VR Aerated	VR Non-Aerated (VR Laminar)
0.35	N/A	<input type="checkbox"/> B-0199-01-N035	N/A	<input type="checkbox"/> B-0199-06-N035
0.5	N/A	<input type="checkbox"/> B-0199-01-N05	N/A	<input type="checkbox"/> B-0199-06-N05
1.0	<input type="checkbox"/> B-0199-01-F10	N/A	<input type="checkbox"/> B-0199-06-F10	N/A
1.5	<input type="checkbox"/> B-0199-01-WS	<input type="checkbox"/> B-0199-29	<input type="checkbox"/> B-0199-06-WS	<input type="checkbox"/> B-0199-29VR
2.2	<input type="checkbox"/> B-0199-01	<input type="checkbox"/> B-0199-21	<input type="checkbox"/> B-0199-06	<input type="checkbox"/> B-0199-21-VRF

Optional Cartridges

- Quarter-Turn Cerama (Standard)
- Eterna
- Quarter-Turn Eterna

Optional Handles

- 4" Wrist Action
- Lever (Standard)
- 4-Arm



T&S BRASS AND BRONZE WORKS, INC.



• 2 Saddleback Cove • Travelers Rest, SC 29690
 Ph 800-476-4103 • Fax 864-834-3518
 • Simi Valley, CA • Ph 800-423-0150 • www.tsbrass.com

Date: 07/05/16