



Architect/Engineering Specifications:

Serrated tip outlet with polished chrome plated brass body, 0.25 GPM flow control tower and 3/8" NPT male inlet. Certified to ASME A112.18.1/CSA B125.1, NSF 61-Section 9 and NSF 372.

Job Name _____

Model Specified _____ Quantity _____

Variations Specified _____

Date _____

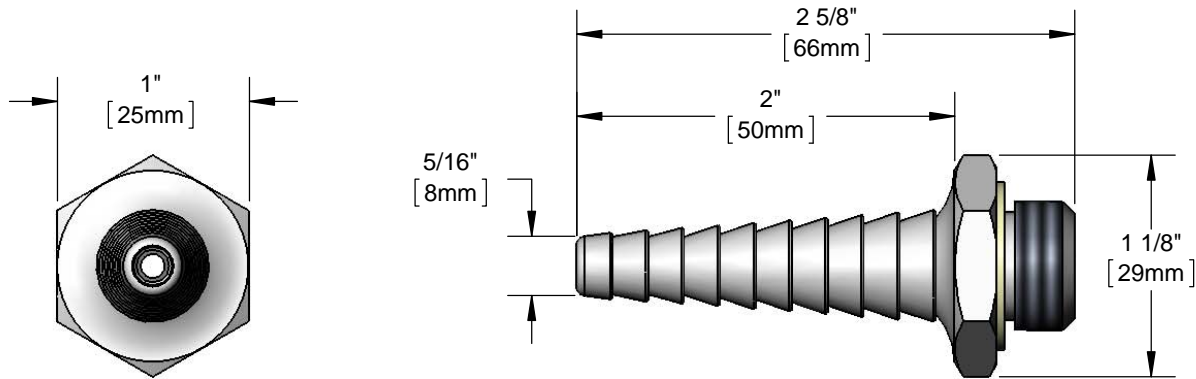
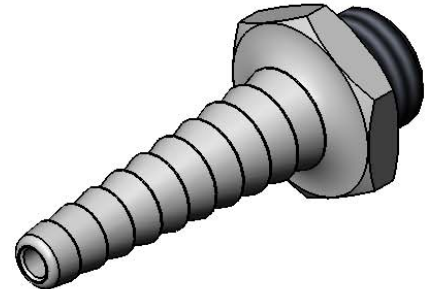

Features & Benefits:

- Serrated tip outlet with polished chrome plated brass body
- 3/8" NPT male inlet
- 0.25 GPM flow tower
- Serrated hose end accepts rubber or plastic tubing up to 1/2" I.D.
- Material: Polished chrome plated brass body

Product Compliance:

- ASME A112.18.1 / CSA B125.1
- NSF 61 - Section 9
- NSF 372 (Low Lead Content)

Warranty: One Year (Limited)

Performance Data:

- Pressure: 20 - 125 PSI
- Temperature: 40 °F - 140 °F
- Flow Rate: 0.25 GPM @ 60 PSI

