

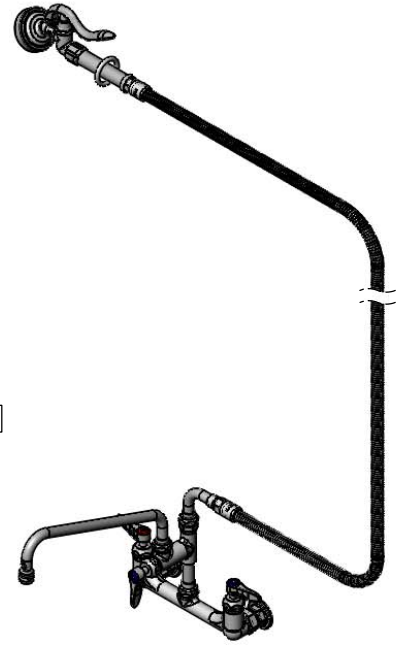

Architect/Engineering Specifications:

8" wall mount mixing faucet with polished chrome plated brass body, add-on faucet with ceramic cartridge and lever handle, 12" swing nozzle with stream regulator outlet, 104" flexible stainless steel hose with heat resistant handle, 90° swivel adapter arm, 1.42 GPM angled spray valve, ceramic cartridges with check valves, lever handles, 1/2" NPT female inlets and hose hanger hook. Certified to ASME A112.18.1/CSA B125.1, NSF 61-Section 9 and NSF 372. EPAAct 2005 compliant.

Job Name _____
 Model Specified _____ Quantity _____
 Variations Specified _____
 Date _____

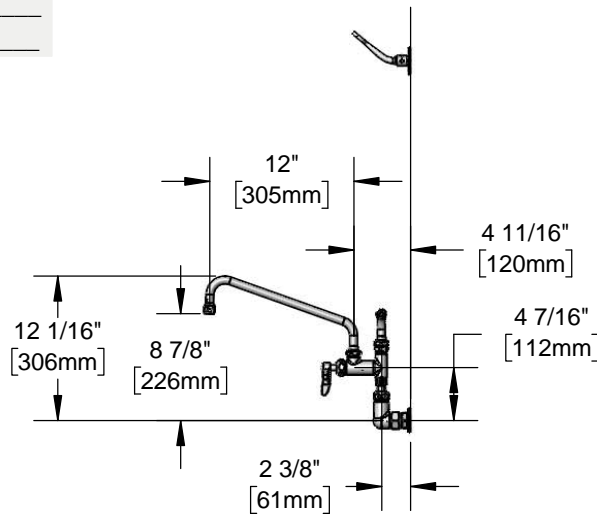
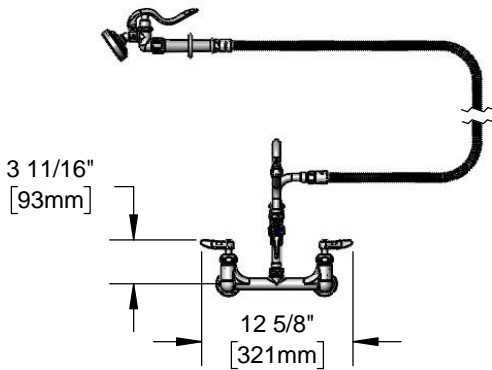

Features & Benefits:

- 8" wall mount mixing faucet w/ polished chrome plated brass body
- EasyInstall add-on faucet w/ polished chrome plated brass body
- 12" swing nozzle w/ stream regulator outlet, Series 1
- 104" flexible stainless steel hose with heat resistant gray handle and hold down ring
- 90° swivel adapter arm
- 1.42 GPM angled spray valve
- Quarter-turn Cerama cartridges w/ check valves to prevent cross flow of water
- Lever handles w/ color coded indexes
- 1/2" NPT female eccentric inlets with Ø 2" flanges
- Adjustable centers from 7 3/4" to 8 1/4"
- Hose hanger hook
- Material: Polished chrome plated brass body, add-on faucet, hanger hook, tubular nozzle, swivel arm and spray valve, stainless steel hose & chrome plated metal handles

Product Compliance:

- ASME A112.18.1 / CSA B125.1
- NSF 61 - Section 9
- NSF 372 (Low Lead Content)
- EPAAct 2005 (PRSV)



Warranty: One Year (Limited)

- Cerama Cartridge: Lifetime (Limited)



Performance Data:

- Pressure: 20 - 125 psi
- Temperature: 40°F - 140°F
- Flow Rate:
 - Spray Valve: 1.42 GPM @ 60 psi
 - Add-On Faucet: 5.35 GPM @ 60 psi

Optional Add-On Faucet Outlets (Series 1 / VR Series 6)

GPM	Aerated	VR Aerated (VR Laminar)
1.0	<input type="checkbox"/> B-0199-01-F10	<input type="checkbox"/> B-0199-06-F10
1.5	<input type="checkbox"/> B-0199-01-WS	<input type="checkbox"/> B-0199-06-WS
2.2	<input type="checkbox"/> B-0199-01	<input type="checkbox"/> B-0199-06

Optional Pre-Rinse Spray Valves

- B-0107 (1.42 GPM)
- B-0107-C (0.65 GPM)
- B-0107-J (1.07 GPM)
- B-0108 (1.48 GPM)
- B-0108-C (0.65 GPM)

Optional Handles

- 4" Wrist Action
- Lever (Standard)
- 4-Arm

Optional Cartridges With Checks

- Quarter-Turn Cerama w/ Check Valve (Standard)
- Quarter-Turn Eterna w/ Spring Check

