



Architect/Engineering Specifications:

Washdown hose unit with polished chrome plated brass body, compression cartridge with spring check, lever handle, 68" flexible stainless steel hose with heat resistant handle, 90° swivel adapter arm, 0.65 GPM low flow angled spray valve and hanger hook. Certified to ASME A112.18.1/CSA B125.1, NSF 61-Section 9 & NSF 372. EPAAct 2005 compliant.

Job Name _____

Model Specified _____ Quantity _____

Variations Specified _____

Date _____

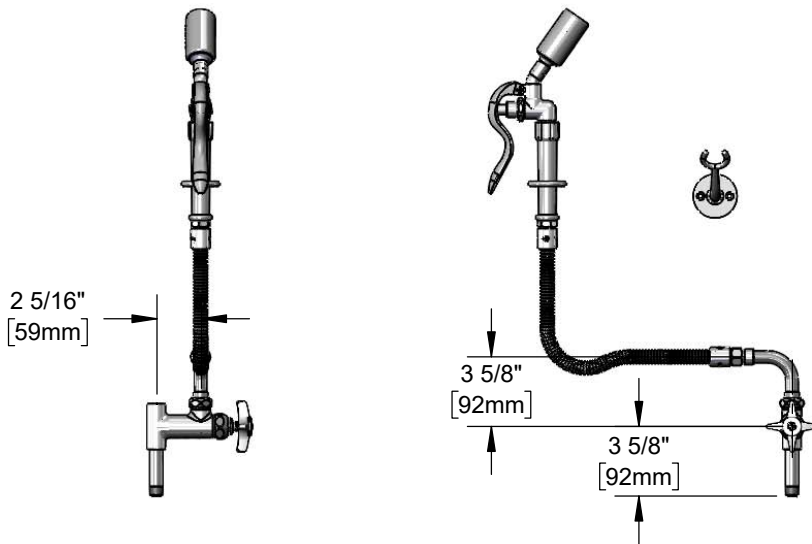

Features & Benefits:

- Washdown hose unit w/ polished chrome plated brass body
- 68" flexible stainless steel hose w/ heat resistant gray handle and hold down ring
- 90° swivel adapter arm
- 0.65 GPM low flow angled spray valve
- Quarter-turn Eterna compression cartridge w/ spring check
- 4-arm handle w/ color coded index
- Hose hanger hook
- 3/8" NPT female outlet
- 3/8" NPT male inlet
- Material: Polished chrome plated brass body, swivel arm & spray valve body, stainless steel hose and chrome plated metal handles

Product Compliance:

- ASME A112.18.1 / CSA B125.1
- NSF 61 - Section 9
- NSF 372 (Low Lead Content)
- EPAAct 2005 (PRSV)



Warranty: One Year (Limited)

Performance Data:

- Pressure: 20 - 125 psi
- Temperature: 40°F - 140°F
- Flow Rate: 0.65 GPM @ 60 psi

Optional Handles

- 4" Wrist Action
- Lever
- 4-Arm (Standard)

Optional Cartridges With Checks

- Quarter-Turn Cerama w/ Check Valve
- Quarter-Turn Eterna w/ Spring Check (Standard)

Optional Pre-Rinse Spray Valves

- B-0107 (1.42 GPM)
- B-0107-C (0.65 GPM)
- B-0107-J (1.07 GPM)
- B-0108 (1.48 GPM)
- B-0108-C (0.65 GPM)

