



Architect/Engineering Specifications:

8" wall mount mixing faucet with polished chrome plated brass body, continuous pressure vacuum breaker, 18" riser, 44" flexible stainless steel hose with heat resistant handle, 1.42 GPM spray valve, compression cartridges with spring checks, lever handles, 1/2" NPT female inlets, 6" adjustable wall bracket, spray valve holder, and overhead spring. Certified to ASME A112.18.1/CSA B125.1, NSF 61-Section 9 and NSF 372. EPAct 2005 compliant.

Job Name _____

Model Specified _____ Quantity _____

Variations Specified _____

Date _____

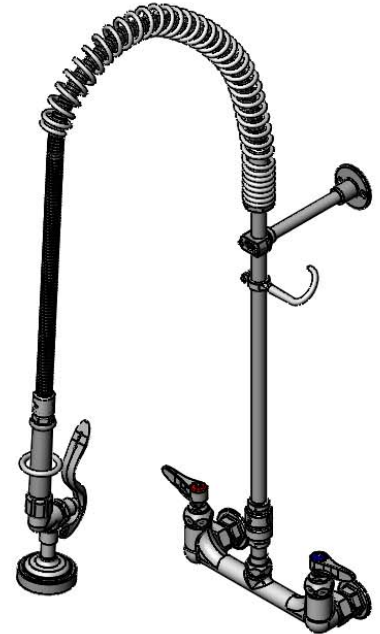
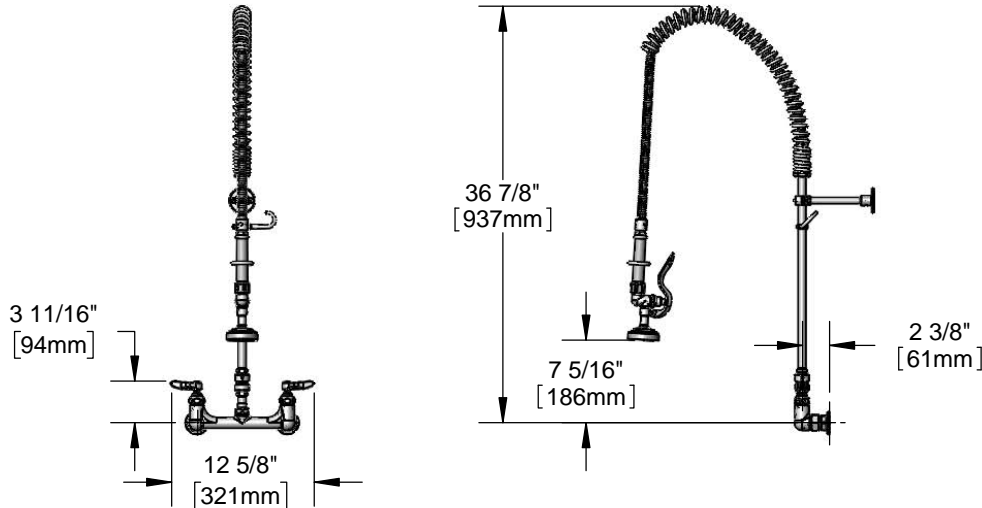

Features & Benefits:

- 8" wall mount mixing faucet w/ polished chrome plated brass body
- EasyInstall riser with continuous pressure vacuum breaker for quick installation
- 44" flexible stainless steel hose w/ heat resistant gray handle and hold down ring
- 1.42 GPM spray valve
- Quarter-turn Eterna compression cartridges with spring checks to prevent cross flow of water
- Lever handles w/ color coded indexes
- 1/2" NPT female eccentric inlets with Ø 2" flanges
- Adjustable centers from 7 3/4" to 8 1/4"
- 6" adjustable wall bracket
- Material: Polished chrome plated brass body, riser & spray valve body, stainless steel hose and chrome plated metal handles

Product Compliance:

- ASME A112.18.1 / CSA B125.1
- NSF 61 - Section 9
- NSF 372 (Low Lead Content)
- CSA B64.8 (VB)
- EPAct 2005 (PRSV)



Warranty: Three Year (Limited)

Performance Data:

- Pressure: 20 - 125 psi
- Temperature: 40 °F - 140 °F
- Flow Rate: 1.42 GPM @ 60 psi

Optional Handles

- 4" Wrist Action
- Lever (Standard)
- 4-Arm

Optional Cartridges With Checks

- Quarter-Turn Cerama w/ Check Valve
- Quarter-Turn Eterna w/ Spring Check (Standard)

Optional Pre-Rinse Spray Valves

- B-0107 (1.42 GPM) (Standard)
- B-0107-C (0.65 GPM)
- B-0107-J (1.07 GPM)
- B-0108 (1.48 GPM)
- B-0108-C (0.65 GPM)

