



Architect/Engineering Specifications:

8" wall mount mixing faucet with polished chrome plated brass body, 18" riser, 44" flexible stainless steel hose with swivel, 1.48 GPM spray valve with insulated grip handle, compression cartridges with spring checks, lever handles, 1/2" NPT female inlets, 6" adjustable wall bracket, spray valve holder and overhead spring. Certified to ASME A112.18.1/CSA B125.1, NSF 61-Section 9 and NSF 372. EPAAct 2005 compliant.

Job Name _____

Model Specified _____ Quantity _____

Variations Specified _____

Date _____

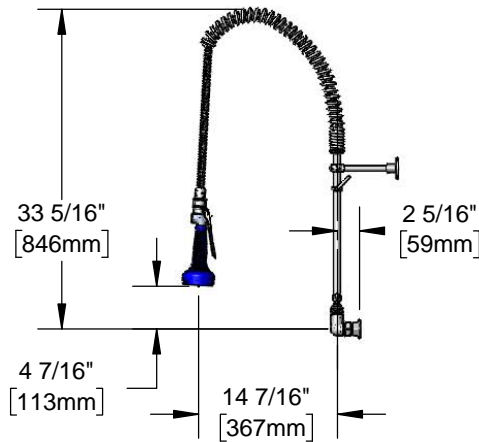
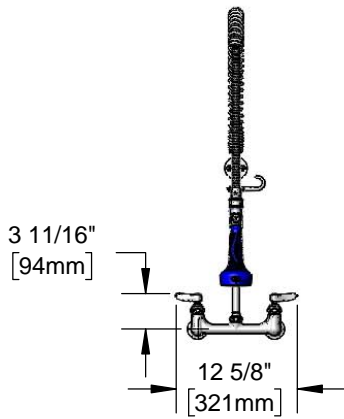

Features & Benefits:

- 8" wall mount mixing faucet w/ polished chrome plated brass body
- EasyInstall 18" riser for quick installation
- 44" flexible stainless steel hose
- 1.48 GPM JeTSpray valve with insulated grip handle, stainless steel trigger and trigger lock
- Quarter-turn Eterna compression cartridges w/ spring checks to prevent cross flow of water
- Pre-rinse swivel
- Lever handles w/ color coded indexes
- 1/2" NPT female eccentric inlets with $\phi 2"$ flanges
- Adjustable centers from 7 3/4" to 8 1/4"
- 6" adjustable wall bracket
- Material: Polished chrome plated brass body, riser & spray valve body, stainless steel hose and chrome plated metal handles

Product Compliance:

- ASME A112.18.1 / CSA B125.1
- NSF 61 - Section 9
- NSF 372 (Low Lead Content)
- EPAAct 2005 (PRSV)



Warranty: Three Year (Limited)

Performance Data:

- Pressure: 20 - 125 psi
- Temperature: 40 °F - 140 °F
- Flow Rate: 1.48 GPM @ 60 psi



Optional Pre-Rinse Spray Valves

- B-0107 (1.42 GPM)
- B-0107-C (0.65 GPM)
- B-0107-J (1.07 GPM)
- B-0108 (1.48 GPM) (Standard)
- B-0108-C (0.65 GPM)

Optional Cartridges With Checks

- Quarter-Turn Cerama w/ Check Valve
- Quarter-Turn Eterna w/ Spring Check (Standard)

Optional Handles

- 4" Wrist Action
- Lever (Standard)
- 4-Arm

