



**Architect/Engineering Specifications:**

8" wall mount mixing faucet with polished chrome plated brass body, add-on faucet with compression cartridge and lever handle, 10" swing nozzle with stream regulator outlet, 18" riser, 44" flexible stainless steel hose with heat resistant handle, 1.42 GPM spray valve with brush attachment, compression cartridges with spring checks, lever handles, installation kit with 1/2" NPT male inlets, (2) 36" flexible stainless steel supply hoses, (2) 1/2" NPT female inlet supply stops, 12" adjustable wall bracket, spray valve holder and overhead spring. Certified to ASME A112.18.1/CSA B125.1, NSF 61-Section 9 and NSF 372. EPAAct 2005 compliant.

Job Name \_\_\_\_\_

Model Specified \_\_\_\_\_ Quantity \_\_\_\_\_

Variations Specified \_\_\_\_\_

Date \_\_\_\_\_

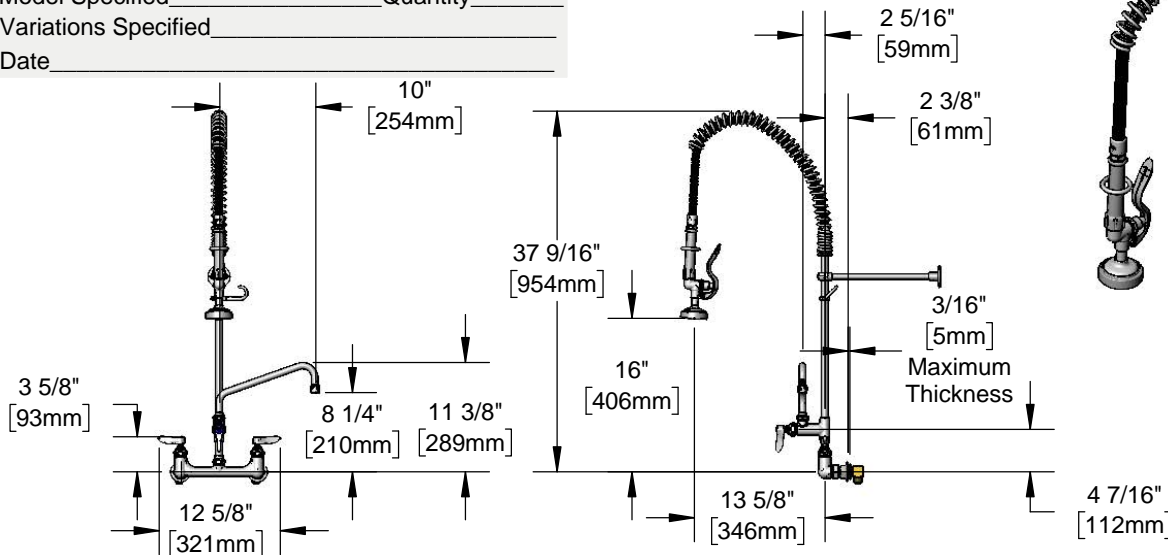

**Features & Benefits:**

- 8" wall mount mixing faucet w/ polished chrome plated brass body
- EasyInstall add-on faucet for quick installation w/ polished chrome plated brass body
- 10" swing nozzle w/ stream regulator outlet, Series 1
- 18" rigid riser
- 44" flexible stainless steel hose with heat resistant gray handle and hold down ring
- 1.42 GPM spray valve w/ brush attachment
- Quarter-turn Eterna compression cartridges with spring checks to prevent cross flow of water
- Lever handles w/ color coded indexes
- 1/2" NPT female eccentric inlets with Ø 2" flanges
- Adjustable centers from 7 3/4" to 8 1/4"
- (2) 36" flexible stainless steel supply hoses w/ 1/2" NPT male x 1/2" NPSM female connectors
- (2) 1/2" NPT female inlet supply stops
- Material: Polished chrome plated brass body, tubular nozzle, add-on faucet body, riser, inlet supply stop bodies & spray valve body, stainless steel hoses and chrome plated metal handles

**Product Compliance:**

- ASME A112.18.1 / CSA B125.1
- NSF 61 - Section 9
- NSF 372 (Low Lead Content)
- EPAAct 2005 (PRSV)



**Warranty:** Three Year (Limited)

**Performance Data:**

- Pressure: 20 - 125 psi
- Temperature: 40 °F - 140 °F
- Flow Rate:
  - Spray Valve: 1.42 GPM @ 60 psi
  - Add-On Faucet: 9.73 GPM @ 60 psi



**Optional Add-On Faucet Outlets (Series 1 / VR Series 6)**

| GPM | Aerated                                | VR Aerated (VR Laminar)                |
|-----|--|--|
| 1.0 | <input type="checkbox"/> B-0199-01-F10 | <input type="checkbox"/> B-0199-06-F10 |
| 1.5 | <input type="checkbox"/> B-0199-01-WS  | <input type="checkbox"/> B-0199-06-WS  |
| 2.2 | <input type="checkbox"/> B-0199-01     | <input type="checkbox"/> B-0199-06     |

**Optional Cartridges With Checks**

- Quarter-Turn Cerama w/ Check Valve
- Quarter-Turn Eterna w/ Spring Check (Standard)

**Optional Handles**

- 4" Wrist Action
- Lever (Standard)
- 4-Arm

**Optional Pre-Rinse Spray Valves**

- B-0107 (1.42 GPM)(Standard)
- B-0107-C (0.65 GPM)
- B-0107-J (1.07 GPM)
- B-0108 (1.48 GPM)
- B-0108-C (0.65 GPM)

