



**Architect/Engineering Specifications:**

8" wall mount mixing faucet with polished chrome plated brass body, add-on faucet with ceramic cartridge and lever handle, 14" swing nozzle with stream regulator outlet, 18" riser, 44" flexible stainless steel hose with swivel, 1.48 GPM spray valve with insulated grip handle, ceramic cartridges with check valves, lever handles, accessory fitting tee and installation kit with 1/2" NPT male inlets, 6" adjustable wall bracket, spray valve holder and overhead spring. Certified to ASME A112.18.1/CSA B125.1, NSF 61-Section 9 and NSF 372. EPAct 2005 compliant.

Job Name \_\_\_\_\_

Model Specified \_\_\_\_\_ Quantity \_\_\_\_\_

Variations Specified \_\_\_\_\_

Date \_\_\_\_\_

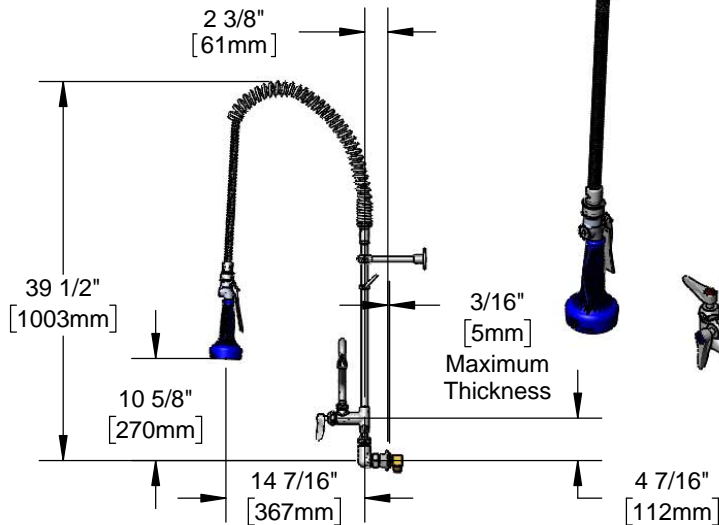
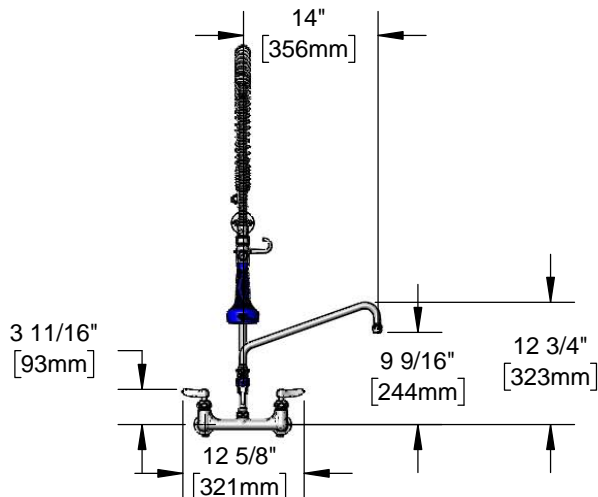

**Features & Benefits:**

- 8" wall mount mixing faucet w/ polished chrome plated brass body
- EasyInstall add-on faucet w/ polished chrome plated brass body
- 14" swing nozzle w/ stream regulator outlet, Series 1
- 18" rigid riser
- 44" flexible stainless steel hose
- 1.48 GPM JeTSpray valve w/ insulated grip handle, stainless steel trigger and trigger lock
- Quarter-turn Cerama cartridges w/ check valves to prevent cross flow of water
- Pre-rinse swivel
- Lever handles w/ color coded indexes
- 3/8" NPT accessory fitting tee
- Installation kit with 1/2" NPT male inlets with  $\varnothing$ 2" flanges
- 6" adjustable wall bracket
- Material: Polished chrome plated brass body, tubular nozzle, add-on faucet, riser & spray valve body, stainless steel hose and chrome plated metal handles

**Product Compliance:**

- ASME A112.18.1 / CSA B125.1
- NSF 61 - Section 9
- NSF 372 (Low Lead Content)
- EPAct 2005 (PRSV)



**Warranty:** Three Year (Limited)

- Cerama Cartridge: Lifetime (Limited)



**Performance Data:**

- Pressure: 20 - 125 psi
- Temperature: 40 °F - 140 °F
- Flow Rate:
  - Spray Valve: 1.48 GPM @ 60 psi
  - Add-On Faucet: 5.35 GPM @ 60 psi

**Optional Cartridges With Checks**

- Quarter-Turn Cerama w/ Check Valve (Standard)
- Quarter-Turn Eterna w/ Spring Check

**Optional Pre-Rinse Spray Valves**

- B-0107 (1.42 GPM)
- B-0107-C (0.65 GPM)
- B-0107-J (1.07 GPM)
- B-0108 (1.48 GPM) (Standard)
- B-0108-C (0.65 GPM)

**Optional Handles**

- 4" Wrist Action
- Lever (Standard)
- 4-Arm

**Optional Add-On Faucet Outlets (Series 1 / VR Series 6)**

GPM	Aerated	VR Aerated (VR Laminar)
1.0	<input type="checkbox"/> B-0199-01-F10	<input type="checkbox"/> B-0199-06-F10
1.5	<input type="checkbox"/> B-0199-01-WS	<input type="checkbox"/> B-0199-06-WS
2.2	<input type="checkbox"/> B-0199-01	<input type="checkbox"/> B-0199-06

