



Architect/Engineering Specifications:

8" wall mount mixing faucet with polished chrome plated brass body, 24" risers, 3/8" NPT pipe coupling, 68" flexible stainless steel hose with heat resistant handle, 0.65 GPM low flow angled spray valve, compression cartridges with spring checks, lever handles, 1/2" NPT female inlets, overhead swivel extension arm with balancer, 6" adjustable wall brackets. Certified to ASME A112.18.1/CSA B125.1, NSF 61-Section 9, and NSF 372. EPAAct 2005 compliant.

Job Name _____

Model Specified _____ Quantity _____

Variations Specified _____

Date _____

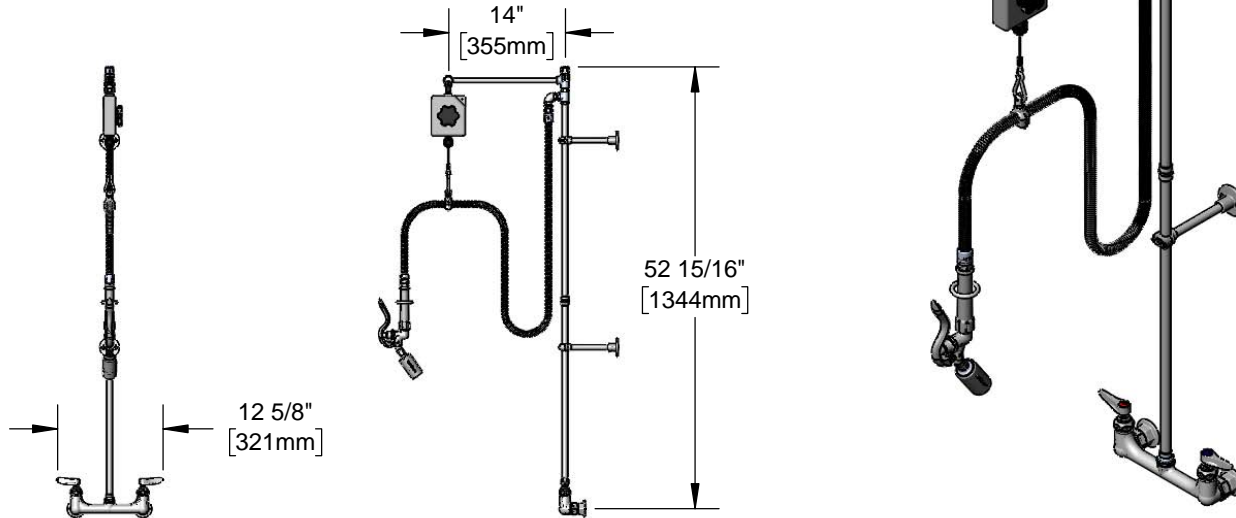

Features & Benefits:

- 8" wall mount mixing faucet with polished chrome plated brass body
- Two 24" risers (one EasyInstall, one rigid) w/ pipe coupling
- Swivel elbow assembly
- 68" flexible stainless steel hose w/ heat resistant gray handle and hold down ring
- 0.65 GPM low flow angled spray valve
- Quarter-turn Eterna compression cartridges w/ spring checks to prevent cross flow of water
- Lever handles w/ color coded indexes
- 1/2" NPT female eccentric inlets with Ø 2" flanges
- Adjustable centers from 7 3/4" to 8 1/4"
- Overhead swivel extension arm with adjustable tension balancer
- 6" adjustable wall brackets
- Material: Polished chrome plated brass body, riser, swivel arm & spray valve body, stainless steel hose, and chrome plated metal handles

Product Compliance:

- ASME A112.18.1 / CSA B125.1
- NSF 61 - Section 9
- NSF 372 (Low Lead Content)
- EPAAct 2005 (PRSV)



Warranty: Three Year (Limited)

Performance Data:

- Pressure: 20 - 125 psi
- Temperature: 40 °F - 140 °F
- Flow Rate: 0.65 GPM @ 60 psi

Optional Handles

- 4" Wrist Action
- Lever (Standard)
- 4-Arm

Optional Cartridges With Checks

- Quarter-Turn Cerama w/ Check Valve
- Quarter-Turn Eterna w/ Spring Check (Standard)

Optional Pre-Rinse Spray Valves

- B-0107 (1.42 GPM)
- B-0107-C (0.65 GPM)
- B-0107-J (1.07 GPM)
- B-0108 (1.48 GPM)
- B-0108-C (0.65 GPM)

