



**Pre-Rinse Units**  
**B-0123-A12-B08**

TAG:

**EasyInstall** Pre-Rinse Unit

**Architect/Engineering Specifications:**

8" deck mount mixing faucet with polished chrome plated brass body, add-on faucet with compression cartridge and lever handle, 12" swing nozzle with stream regulator outlet, 24" riser, 44" flexible stainless steel hose, 1.48 GPM spray valve with insulated grip handle, compression cartridges with spring checks, lever handles, 1/2" NPT female inlets, spray valve holder, 6" adjustable wall bracket and overhead spring. Certified to ASME A112.18.1/CSA B125.1, NSF 61-Section 9 and NSF 372. EPAAct 2005 compliant.

Job Name \_\_\_\_\_  
 Model Specified \_\_\_\_\_ Quantity \_\_\_\_\_  
 Variations Specified \_\_\_\_\_  
 Date \_\_\_\_\_

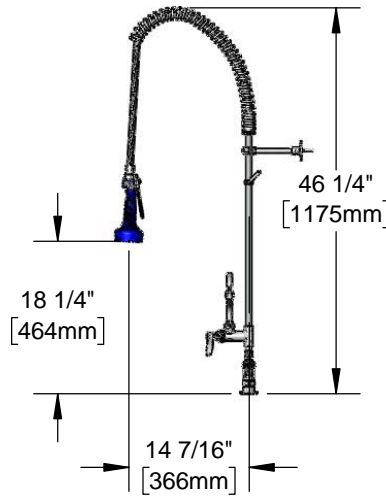
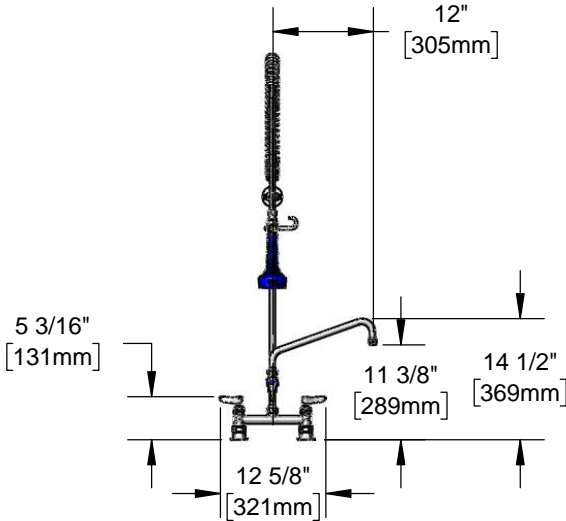

**Features & Benefits:**

- Single hole deck mount w/ polished chrome plated brass body
- EasyInstall add-on faucet w/ polished chrome plated brass body
- 12" swing nozzle w/ stream regulator outlet, Series 1
- 24" rigid riser
- 44" flexible stainless steel hose
- 1.48 GPM spray valve
- Quarter-Turn Eterna compression cartridges w/ spring checks to prevent cross flow of water
- Lever handles w/ color coded indexes
- 1/2" NPT female inlets
- 6" adjustable wall bracket
- Material: Polished chrome plated brass body, add-on faucet, riser and spray valve, stainless steel hose & chrome plated metal handles

**Product Compliance:**

- ASME A112.18.1 / CSA B125.1
- NSF 61 - Section 9
- NSF 372 (Low Lead Content)
- EPAAct 2005 (PRSV)



**Warranty:** Three Year (Limited)

**Performance Data:**

- Pressure: 20 - 125 psi
- Temperature: 40 °F - 140 °F
- Flow Rate:  
 Spray Valve: 1.48 GPM @ 60 psi  
 Add-On Faucet: 6.49 GPM @ 60 psi

**Optional Add-On Faucet Outlets (Series 1 / VR Series 6)**

GPM	Aerated	VR Aerated (VR Laminar)
1.0	<input type="checkbox"/> B-0199-01-F10	<input type="checkbox"/> B-0199-06-F10
1.5	<input type="checkbox"/> B-0199-01-WS	<input type="checkbox"/> B-0199-06-WS
2.2	<input type="checkbox"/> B-0199-01	<input type="checkbox"/> B-0199-06

**Optional Cartridges With Checks**

- Quarter-Turn Cerama w/ Check Valve
- Quarter-Turn Eterna w/ Spring Check (Standard)

**Optional Pre-Rinse Spray Valves**

- B-0107 (1.42 GPM)
- B-0107-C (0.65 GPM)
- B-0107-J (1.07 GPM)
- B-0108 (1.48 GPM)(Standard)
- B-0108-C (0.65 GPM)

**Optional Handles**

- 4" Wrist Action
- Lever (Standard)
- 4-Arm



**T&S BRASS AND BRONZE WORKS, INC.**



• 2 Saddleback Cove • Travelers Rest, SC 29690  
 Ph 800-476-4103 • Fax 864-834-3518  
 • Simi Valley, CA • Ph 800-423-0150 • www.tsbrass.com

Date: 11/01/17