



**Architect/Engineering Specifications:**

Single hole deck mount mixing faucet with polished chrome plated brass body, vacuum breaker, 24" riser, 44" flexible stainless steel hose with heat resistant handle, 0.65 GPM low flow spray valve, compression cartridges with spring checks, lever handles, 6" adjustable wall bracket, 18" flexible stainless steel supply hoses with 1/2" NPSM / 5/8" compression connections, spray valve holder and overhead spring. Certified to ASME A112.18.1/CSA B125.1, NSF 61-Section 9, NSF 372 and CSA B64.8. EPAAct 2005 compliant.

Job Name \_\_\_\_\_

Model Specified \_\_\_\_\_ Quantity \_\_\_\_\_

Variations Specified \_\_\_\_\_

Date \_\_\_\_\_

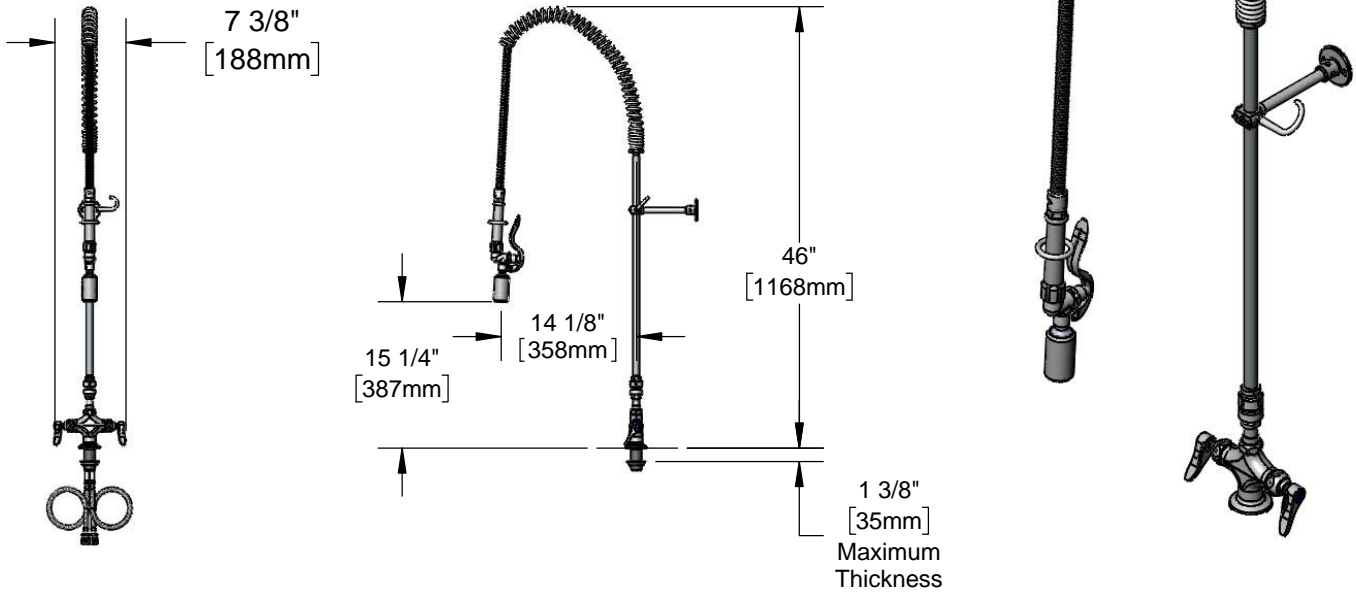

**Features & Benefits:**

- Single hole deck mount mixing faucet w/ polished chrome plated brass body
- EasyInstall vacuum breaker for quick installation
- 24" Riser
- 44" flexible stainless steel hose w/ heat resistant gray handle and hold down ring
- 0.65 GPM low flow spray valve
- Quarter-turn Eterna compression cartridges with spring checks to prevent cross flow of water
- Lever handles w/ color coded indexes
- 6" adjustable wall bracket
- 18" flexible stainless steel supply hoses w/ 1/2" NPSM / 5/8" compression connections
- Material: Polished chrome plated brass body, riser & spray valve, stainless steel hose, chrome plated metal handles and wall bracket.

**Product Compliance:**

- ASME A112.18.1 / CSA B125.1
- NSF 61 - Section 9
- NSF 372 (Low Lead Content)
- EPAAct 2005 (PRSV)
- CSA B64.8 (VB)
- EPA WaterSense (PRSV)



**Warranty:** Three Year (Limited)

**Performance Data:**

- Pressure: 20 - 125 psi
- Temperature: 40 °F - 140 °F
- Flow Rate: 0.65 GPM @ 60 psi

**Optional Handles**

- 4" Wrist Action
- Lever (Standard)
- 4-Arm

**Optional Cartridges With Checks**

- Quarter-Turn Cerama w/ Check Valve
- Quarter-Turn Eterna w/ Spring Check (Standard)

**Optional Pre-Rinse Spray Valves**

- B-0107 (1.42 GPM)
- B-0107-C (0.65 GPM) (Standard)
- B-0107-J (1.07 GPM)
- B-0108 (1.48 GPM)
- B-0108-C (0.65 GPM)

