



**Pre-Rinse Units**  
**B-0113-CR-V-BC**

TAG:

**EasyInstall** Pre-Rinse Unit

**Architect/Engineering Specifications:**

Single hole deck mount mixing faucet with polished chrome plated brass body, 20" riser, 44" flexible stainless steel hose with heat resistant handle, 0.65 GPM low flow spray valve, ceramic cartridges with check valves, lever handles, vacuum breaker, 6" adjustable wall bracket, spray valve holder and overhead spring. Certified to ASME A112.18.1/CSA B125.1, NSF 61-Section 9 and NSF 372. EPAAct 2005 compliant.

Job Name \_\_\_\_\_  
 Model Specified \_\_\_\_\_ Quantity \_\_\_\_\_  
 Variations Specified \_\_\_\_\_  
 Date \_\_\_\_\_

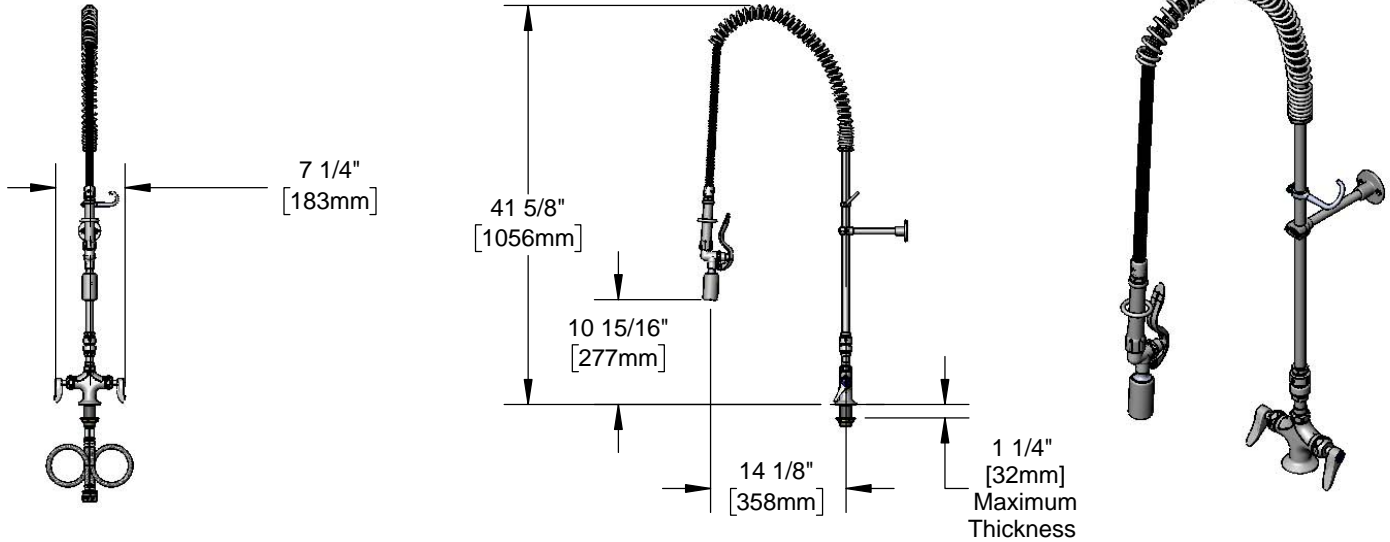

**Features & Benefits:**

- Single hole deck mount mixing faucet w/ polished chrome plated brass body
- 20" rigid riser
- 44" flexible stainless steel hose w/ heat resistant gray handle and hold down ring
- 0.65 GPM low flow spray valve
- Quarter-turn Cerama cartridges w/ check valves to prevent cross flow of water
- Lever handles w/ color coded indexes
- EasyInstall 3/8" NPT Vacuum Breaker
- 6" adjustable wall bracket
- Material: Polished chrome plated brass body, riser & spray valve body, stainless steel hose and chrome plated metal handles

**Product Compliance:**

- ASME A112.18.1 / CSA B125.1
- NSF 61 - Section 9
- NSF 372 (Low Lead Content)
- EPAAct 2005 (PRSV)
- CSA B64.8 (VB)
- EPA WaterSense (PRSV)



**Warranty:** Three Year (Limited)

- Cerama Cartridge: Lifetime (Limited)

**Performance Data:**

- Pressure: 20 - 125 psi
- Temperature: 40 °F - 140 °F
- Flow Rate: 0.65 GPM @ 60 psi

**Optional Handles**

- 4" Wrist Action
- Lever (Standard)
- 4-Arm

**Optional Cartridges With Checks**

- Quarter-Turn Cerama w/ Check Valve (Standard)
- Quarter-Turn Eterna w/ Spring Check

**Optional Pre-Rinse Spray Valves**

- B-0107 (1.42 GPM)
- B-0107-C (0.65 GPM) (Standard)
- B-0107-J (1.07 GPM)
- B-0108 (1.48 GPM)
- B-0108-C (0.65 GPM)



**T&S BRASS AND BRONZE WORKS, INC.**



• 2 Saddleback Cove • Travelers Rest, SC 29690  
 Ph 800-476-4103 • Fax 864-834-3518  
 • Simi Valley, CA • Ph 800-423-0150 • www.tsbrass.com

Date: 05/05/17