



Architect/Engineering Specifications:

Rosespray with 0.7 GPM flow tower, holder and 3/8" NPSM male threads. Certified to ASME A112.18.1/CSA B125.1, NSF 61-Section 9 and NSF 372.

Job Name _____

Model Specified _____ Quantity _____

Variations Specified _____

Date _____

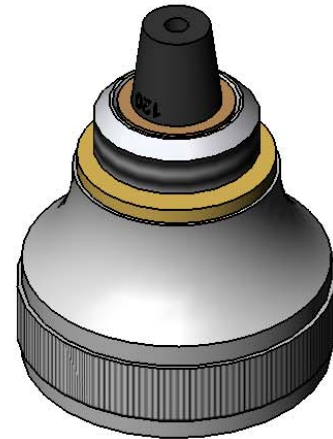
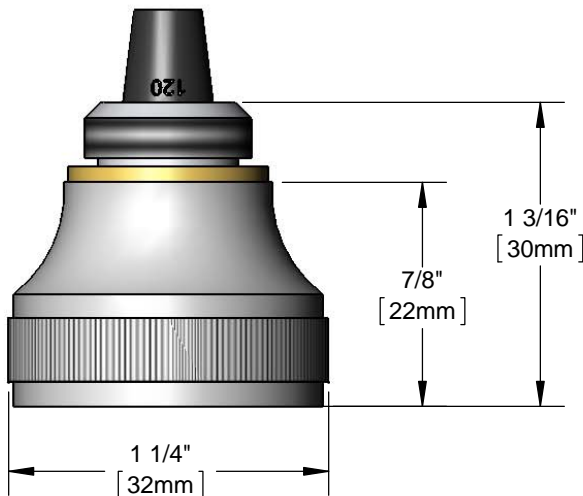

Features & Benefits:

- Rosespray w/ 0.7 GPM flow tower and holder
- 3/8" NPSM male thread
- Washer included
- Fits all T&S nozzles
- Material: Solid brass body

Product Compliance:

- ASME A112.18.1 / CSA B125.1
- NSF 61 - Section 9
- NSF 372 (Low Lead Content)



Warranty: One Year (Limited)

Performance Data:

- Pressure: 20 - 125 psi
- Temperature: 40 °F - 140 °F
- Flow Rate: 0.7 GPM @ 60 psi

