

Architect/Engineering Specifications:

Single hole deck mount mixing faucet with polished chrome plated brass body, 8 1/8" swing nozzle with full flow laminar flow device, ceramic cartridges, lever handles, 18" flexible stainless steel supply hoses with 1/2" NPSM / 5/8" O.D. compression connections. Certified to ASME A112.18.1/CSA B125.1, NSF 61-Section 9 and NSF 372. Meets ADA ANS/ICC A117.1 requirements.

Job Name _____
 Model Specified _____ Quantity _____
 Variations Specified _____
 Date _____

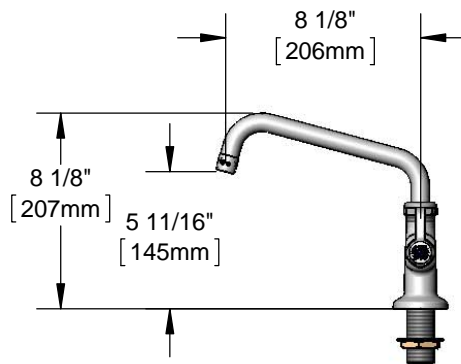
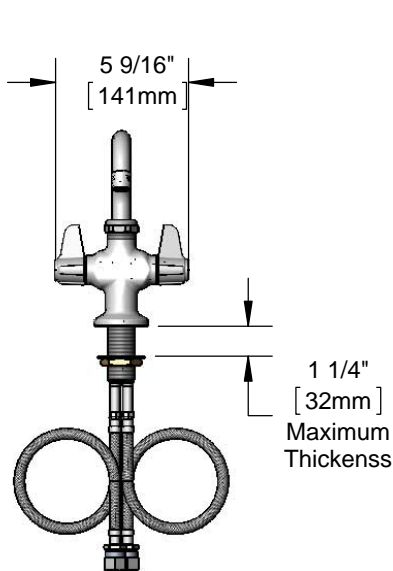

Features & Benefits:

- Single hole deck mount mixing faucet w/ polished chrome plated brass body
- 8 1/8" swing nozzle w/ full flow laminar flow device
- Quarter-turn ceramic cartridges
- equip lever handles
- 18" flexible stainless steel supply hoses w/ 1/2" NPSM / 5/8" O.D. compression connections
- Material: Polished chrome plated brass body and chrome plated metal handles

Product Compliance:

- ASME A112.18.1 / CSA B125.1
- NSF 61 - Section 9
- NSF 372 (Low Lead Content)
- ANSI A117.1 (ADA)

Warranty: One Year (Limited)

Performance Data:

- Pressure: 20 - 125 psi
- Temperature: 40 °F - 140 °F
- Flow Rate: 4.65 GPM @ 60 psi



ADA Compliant