



Architect/Engineering Specifications:

Single hole deck mount electronic sensor faucet with polished chrome plated brass body and 5 11/16" plain end swivel/rigid gooseneck w/ 1.0 GPM flow regulator, above deck electronic AC/DC control module with internal flow control setting switches, above deck temperature mixing handle, anti-rotation pin, 19" flexible stainless steel supply hoses and check valve adapters with 3/8" compression connections. Certified to ASME A112.18.1/CSA B125.1, NSF 61-Section 9, NSF 372 and UL 1951. Meets ADA ANSI/ICC A117.1 requirements.

Job Name _____

Model Specified _____ Quantity _____

Variations Specified _____

Date _____

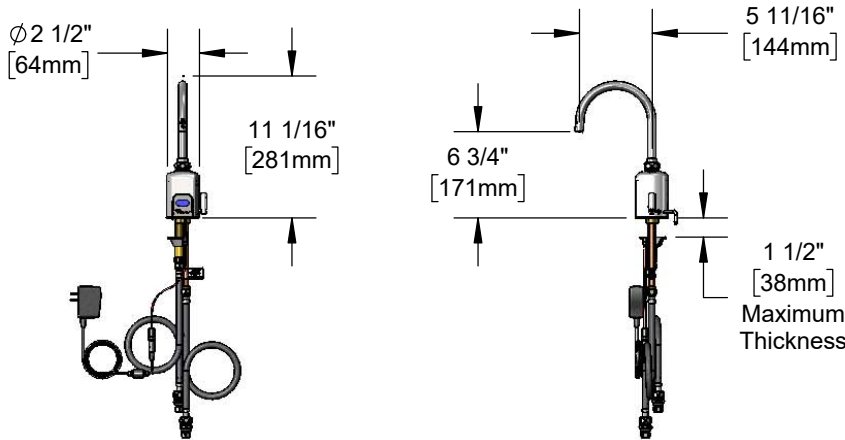

Features & Benefits:

- Single hole deck mount faucet with polished chrome plated brass body
- 5 11/16" plain end swivel/rigid gooseneck
- 1.0 GPM flow regulator in swivel piece
- Above deck electronic control module w/ internal flow control switches for adjusting auto time out & shut off delay settings
- Optional auto flush feature flows water for 30 seconds after every 12 inactive hours
- Plug in AC transformer or 6 VDC lithium battery (DC) power options
- Above deck temperature mixing handle
- Optional body plug replaces handle when temperature is preset
- Anti-rotation pin
- 19" flexible stainless steel supply hoses with filter washers
- Check valve adapters with 3/8" compression connections
- Low battery LED indicator light
- Material: Polished chrome plated brass body and tubular spout

Product Compliance:

- ASME A112.18.1 / CSA B125.1
- NSF 61 - Section 9
- NSF 372 (Low Lead Content)
- ANSI A117.1 (ADA)
- UL 1951



Warranty: Three Year (Limited)



Performance Data:

- Pressure: 20 - 125 psi
- Temperature: 40 °F - 140 °F
- Flow Rate: 1.0 GPM @ 60 psi
- Water Consumption: @ 10 sec = .17 gal
@ 15 sec = .25 gal



Optional Deck Plates

- 4" Chrome Plated Brass Deck Plate
- 8" Chrome Plated Brass Deck Plate

