



# Electronic Faucets

## EC-3103-VF12

TAG:



**ChekPoint™** *Electronic Sensor Faucet*

### Architect/Engineering Specifications:

4" deck mount electronic sensor faucet with polished chrome plated brass body with integral spout, 1.2 GPM vandal resistant aerator, AC/DC control module with internal flow control setting switches, temperature control mixing valve with integral check valves and 18" flexible stainless steel supply hoses with 3/8" compression connections. Certified to ASME A112.18.1/CSA B125.1, NSF 61-Section 9, NSF 372, EPA WaterSense and UL 1951. Meets ADA ANSI/ICC A117.1 requirements.

Job Name \_\_\_\_\_  
 Model Specified \_\_\_\_\_ Quantity \_\_\_\_\_  
 Variations Specified \_\_\_\_\_  
 Date \_\_\_\_\_

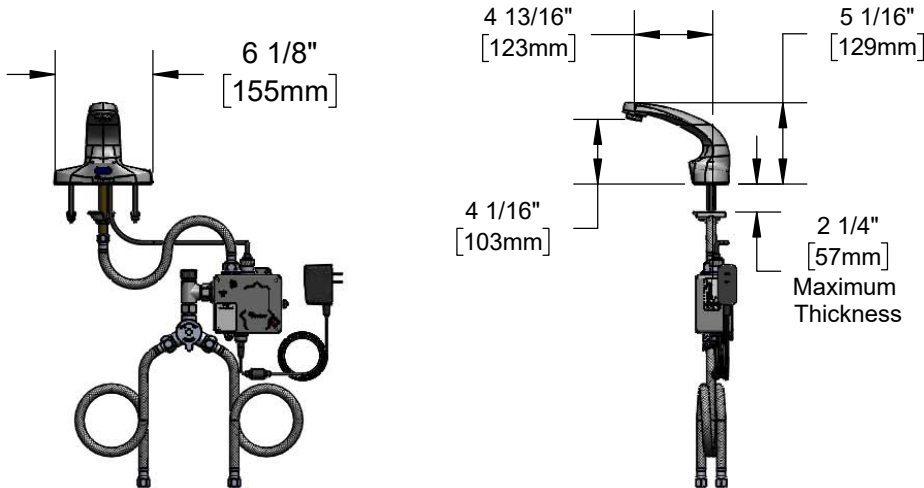

### Features & Benefits:

- 4" deck mount faucet w/ polished chrome plated brass body with integral spout
- 1.2 GPM vandal resistant aerator, Series 8 (B-0199-08-F12)
- Water resistant control module w/ internal flow control switches for adjusting auto time out & shut off delay settings
- Optional auto flush feature flows water for 30 seconds after every 12 inactive hours
- Plug in AC transformer or (4) AA battery (DC) power options
- Mechanical temperature mixing valve with integral check valves
- 18" flexible stainless steel supply hoses with 3/8" compression connections
- Low battery LED indicator light
- Material: Polished chrome plated brass body

### Product Compliance:

- ASME A112.18.1 / CSA B125.1
- NSF 61 - Section 9
- NSF 372 (Low Lead Content)
- ANSI A117.1 (ADA)
- UL 1951
- EPA WaterSense



**Warranty:** Three Year (Limited)



**ADA Compliant**

### Performance Data:

- Pressure: 20 - 125 psi
- Temperature: 40 °F - 140 °F
- Flow Rate: 1.2 GPM @ 60 psi
- Water Consumption: @10 sec=.20 gal  
@15 sec=.30 gal



### Optional Outlets (Series 3 / VR Series 8)

GPM	Aerated	Non-Aerated (Laminar)	VR Aerated	VR Non-Aerated (VR Laminar)
0.35	N/A	<input type="checkbox"/> B-0199-03-N035	N/A	<input type="checkbox"/> B-0199-08-N035
0.5	N/A	<input type="checkbox"/> B-0199-03-N05	N/A	<input type="checkbox"/> B-0199-08-N05
1.0	N/A	N/A	N/A	<input type="checkbox"/> B-0199-08-LF10
1.2	<input type="checkbox"/> B-0199-03-F12	N/A	Standard	N/A
1.5	<input type="checkbox"/> B-0199-03-WS	N/A	<input type="checkbox"/> B-0199-08-WS	<input type="checkbox"/> B-0199-08-LF15
2.2	<input type="checkbox"/> B-0199-03	<input type="checkbox"/> B-0199-26	<input type="checkbox"/> B-0199-08	<input type="checkbox"/> B-0199-28



**T&S BRASS AND BRONZE WORKS, INC.**



• 2 Saddleback Cove • Travelers Rest, SC 29690  
 Ph 800-476-4103 • Fax 864-834-3518  
 • Simi Valley, CA • Ph 800-423-0150 • www.tsbrass.com

Date: 10/31/19