



T&S BRASS AND BRONZE WORKS, INC.

2 Saddleback Cove / P.O. Box 1088
Travelers Rest, SC 29690

Model No.

B-0892-122X

Item No.

Travelers Rest, SC: 800-476-4103 • Simi Valley, CA: 800-423-0150 • Fax: 864-834-3518 • www.tsbrass.com



ADA Compliant

This Space for Architect/Engineer Approval

Job Name _____ Date _____

Model Specified _____ Quantity _____

Customer/Wholesaler _____

Contractor _____

Architect/Engineer _____

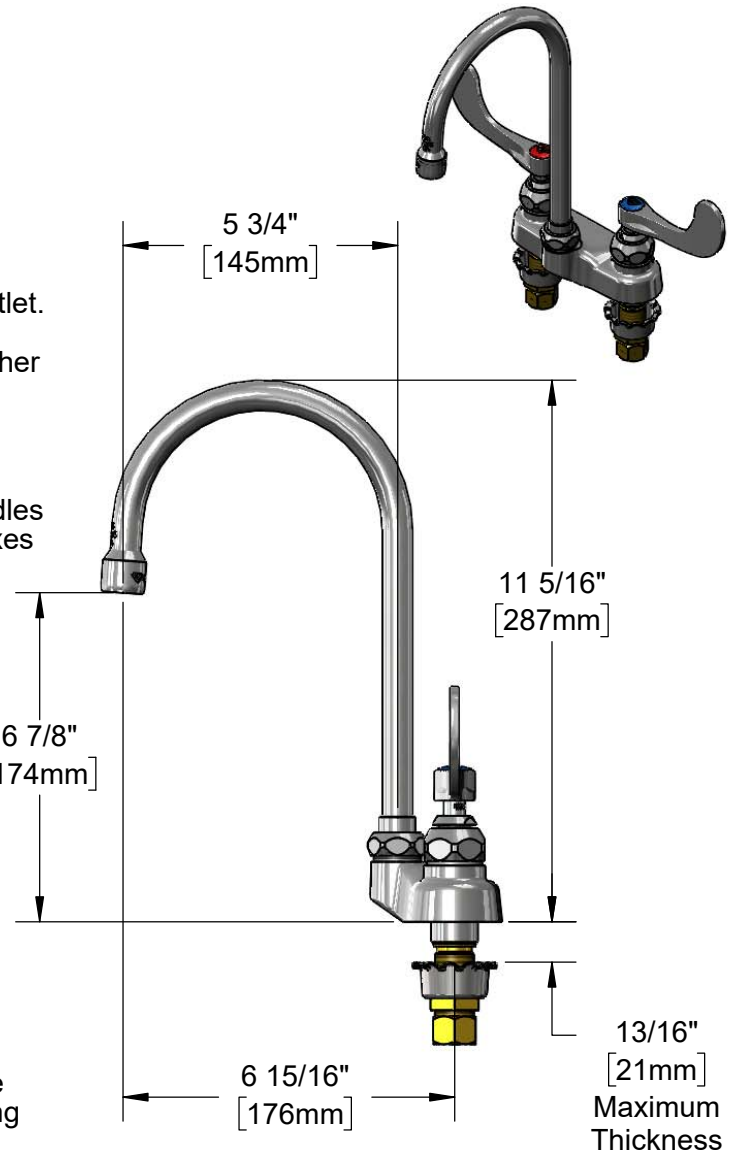
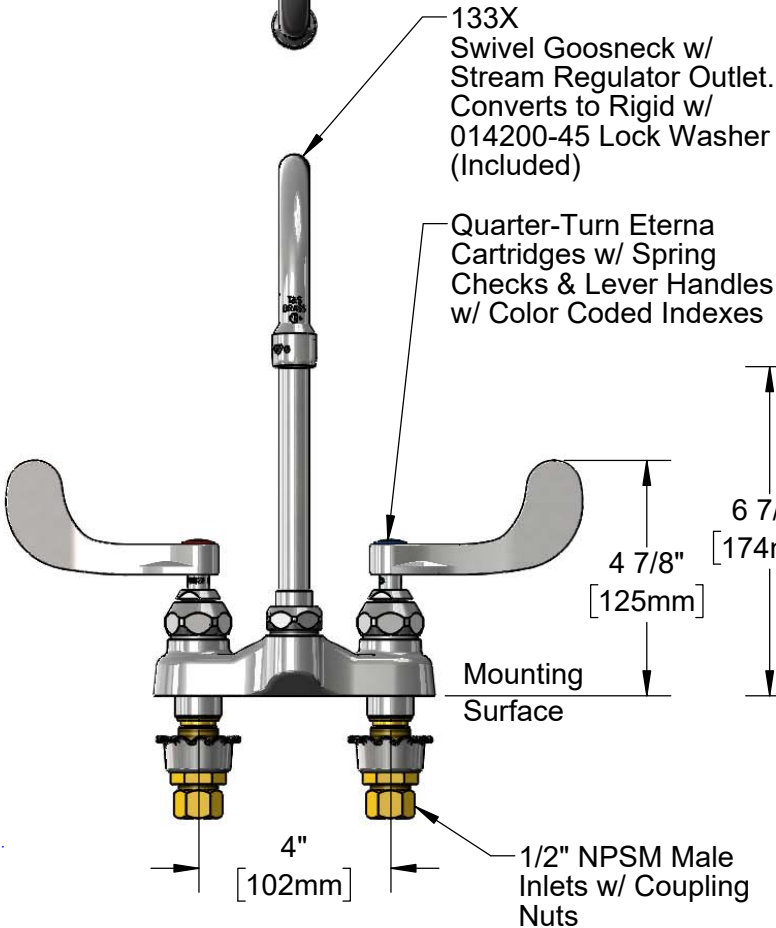
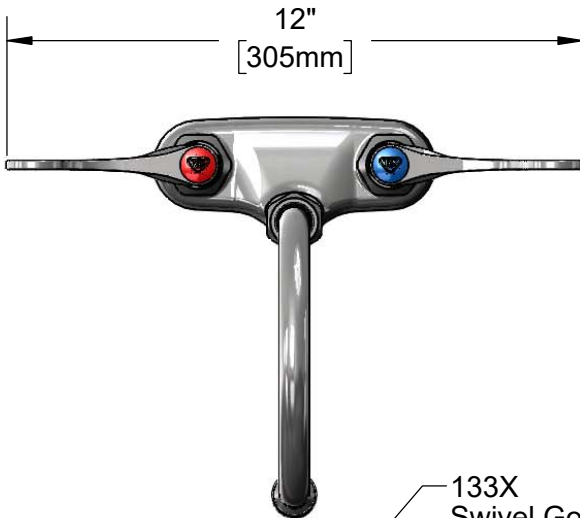

Rough-In Requirement:
(2) ϕ 1 1/8" [29mm] Mounting Holes

Product Specifications:
4" Centerset Deck Mount Mixing Faucet, Quarter-Turn Eterna Cartridges w/ Spring Checks, 4" Wrist Action Handles, 5 3/4" Swivel Gooseneck, Stream Regulator Outlet & 1/2" NPSM Male Inlets

Product Compliance:
ASME A112.18.1 / CSA B125.1
NSF 61 - Section 9
NSF 372 (Low Lead Content)
ANSI A117.1 (ADA)



T&S BRASS AND BRONZE WORKS, INC.

2 Saddleback Cove / P.O. Box 1088
Travelers Rest, SC 29690

Model No.

B-0892-122X

Item No.

Travelers Rest, SC: 800-476-4103 • Simi Valley, CA: 800-423-0150 • Fax: 864-834-3518 • www.tsbrass.com

ITEM NO.	SALES NO.	DESCRIPTION
1	B-PT	Full Flow Stream Regulator, 55/64-27
2	133X	5 3/4" Swivel Gooseneck w/ Stream Regulator Outlet
3	009538-45	Swivel Washer
4	011429-45	Swivel Sleeves (2)
5	001074-45	O-Ring
6	014200-45	Star Washer, Anti-Rotation
7	018506-19NS	Blue Button Index, Press-in
8	000925-45	Lab Handle Screw
9	B-WH4C-NS	Wrist Action Handle, Blue Index & Screw
10	012442-40NS	Quarter-Turn Eterna Cartridge w/ Spring Check, LTC
11	001000-45	Rosette Washer
12	002954-45	Shank Lock Nut
13	000958-20	Coupling Nut
14	012443-40NS	Quarter-Turn Eterna Cartridge w/ Spring Check, RTC
15	B-WH4-NS	Wrist Action Handle (New Style)
16	B-WH4H-NS	Wrist Action Handle, Red Index & Screw
17	001193-19NS	Red Button Index, Press-in

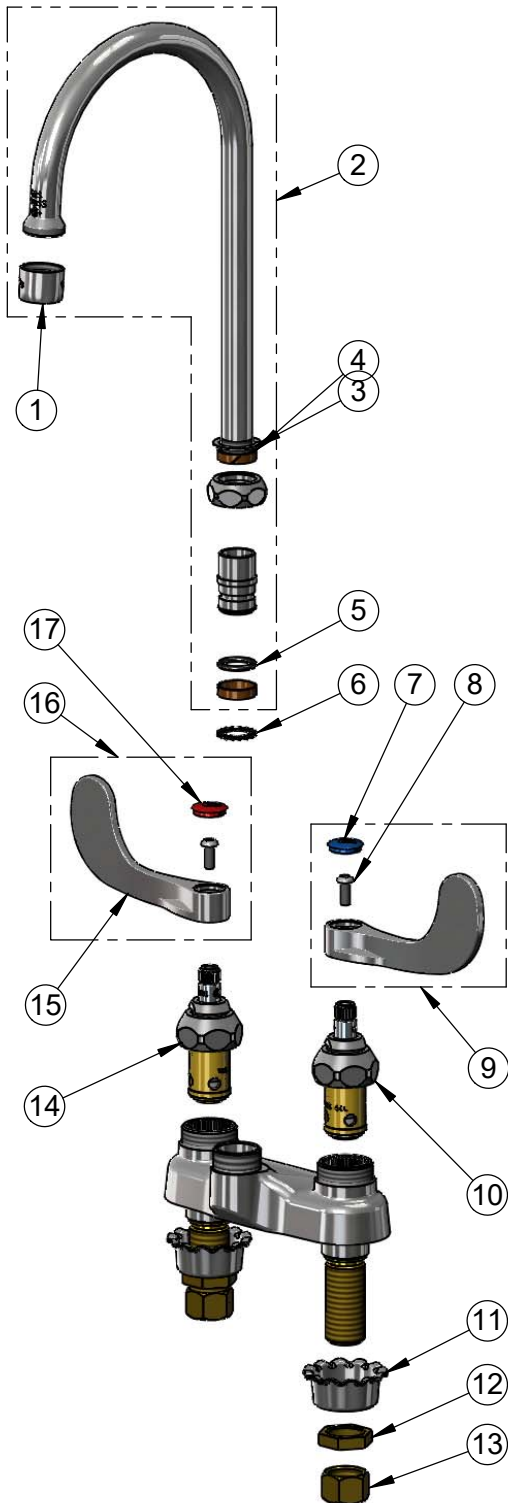

Product Specifications:

4" Centerset Deck Mount Mixing Faucet, Quarter-Turn Eterna Cartridges w/ Spring Checks, 4" Wrist Action Handles, 5 3/4" Swivel Gooseneck, Stream Regulator Outlet & 1/2" NPSM Male Inlets

Product Compliance:

ASME A112.18.1 / CSA B125.1
NSF 61 - Section 9
NSF 372 (Low Lead Content)
ANSI A117.1 (ADA)