



T&S BRASS AND BRONZE WORKS, INC.

2 Saddleback Cove / P.O. Box 1088
Travelers Rest, SC 29690

Model No.

B-0123-08

Item No.

Travelers Rest, SC: 800-476-4103 • Simi Valley, CA: 800-423-0150 • Fax: 864-834-3518 • www.tsbrass.com

This Space for Architect/Engineer Approval

Job Name _____ Date _____

Model Specified _____ Quantity _____

Customer/Wholesaler _____

Contractor _____

Architect/Engineer _____

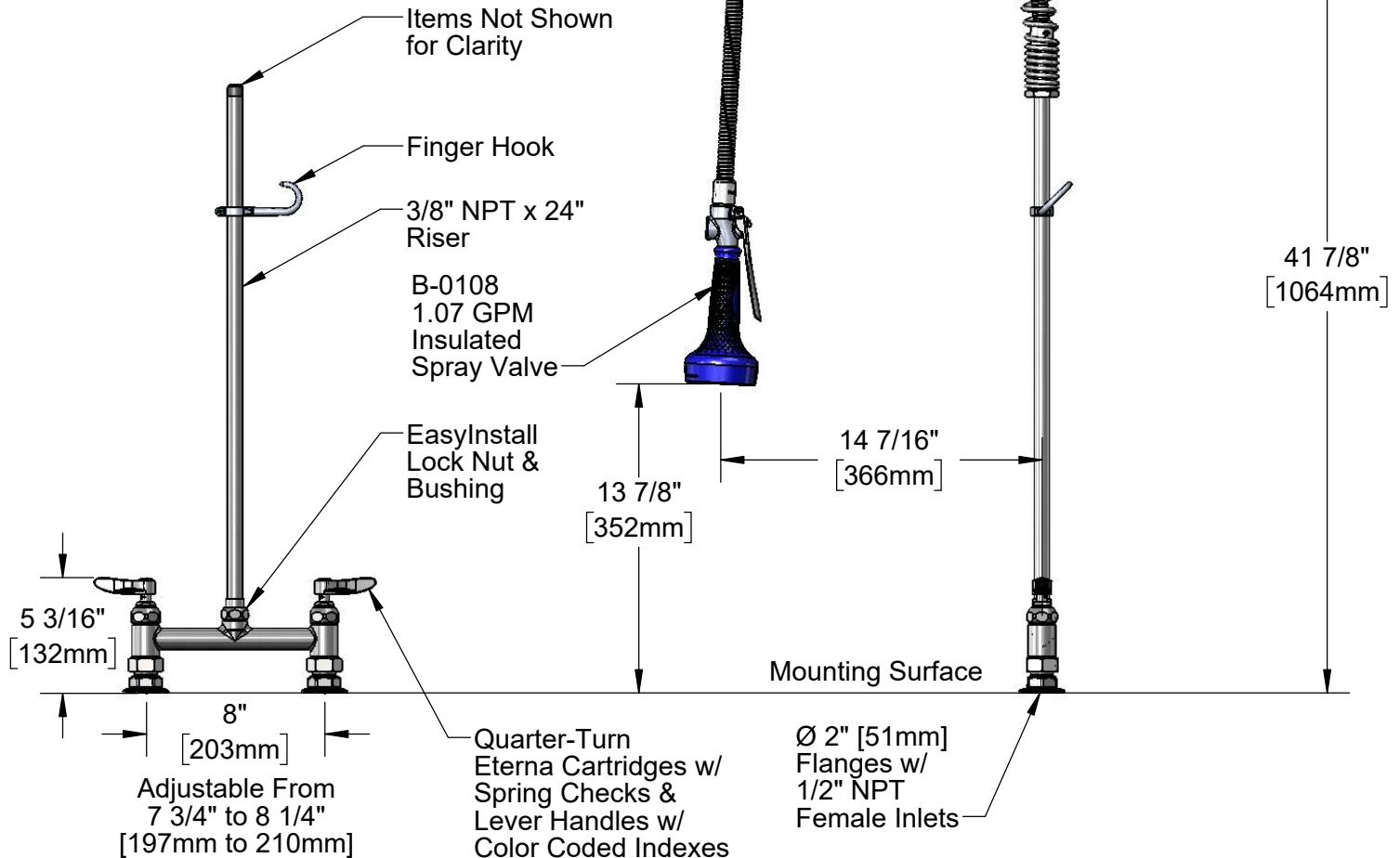
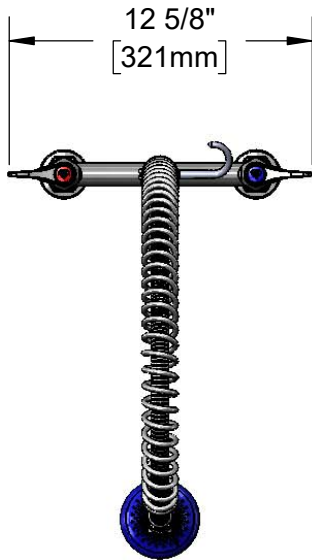

Product Specifications:

Pre-Rinse Unit: EasyInstall 8" Deck Mount Mixing Faucet, Quarter-Turn Eterna Cartridges w/ Spring Checks, Lever Handles, 44" Flexible Stainless Steel Hose, 1.07 GPM Spray Valve, 24" Riser & 1/2" NPT Female Inlets

Product Compliance:

ASME A112.18.1 / CSA B125.1
NSF 61 - Section 9
NSF 372 (Low Lead Content)
EPA Act 2005 (PRSV)



T&S BRASS AND BRONZE WORKS, INC.

2 Saddleback Cove / P.O. Box 1088
Travelers Rest, SC 29690

Model No.

B-0123-08

Item No.

Travelers Rest, SC: 800-476-4103 • Simi Valley, CA: 800-423-0150 • Fax: 864-834-3518 • www.tsbrass.com

ITEM NO.	SALES NO.	DESCRIPTION
1	B-0108	1.07 GPM Spray Valve w/ Ergo-Grip
2	001014-45	Washer, B-0100 Hose Barrel
3	B-0044-H2A	44" Stainless Steel Flex Hose - Less Handle
4	000888-45	EasyInstall Overhead Spring
5	010476-45	#27 Washer
6	000821-40	Spring Body
7	004R	Finger Hook
8	00372-40	3/8" NPT x 24" Riser
9	EZ-K	EasyInstall Kit: Bushing, O-ring, & Lock Washer
10	001065-45	O-Ring
11	014200-45	Star Washer, Anti-Rotation
12	018506-19NS	Blue Button Index, Press-in
13	000925-45	Lab Handle Screw
14	012442-40NS	Quarter-Turn Eterna Cartridge w/ Spring Check, LTC
15	002711-40NS	Quarter-Turn Eterna Cartridge w/ Spring Check, Handle, Blue Index & Screw, LTC
16	001019-45	Coupling Nut Washer
17	00AA	1/2" NPT Female Eccentric Flange
18	012443-40NS	Quarter-Turn Eterna Cartridge w/ Spring Check, RTC
19	002712-40NS	Quarter-Turn Eterna Cartridge w/ Spring Check, Handle, Red Index & Screw, RTC
20	001638-45NS	Lever Handle (New Style)
21	001193-19NS	Red Button Index, Press-in

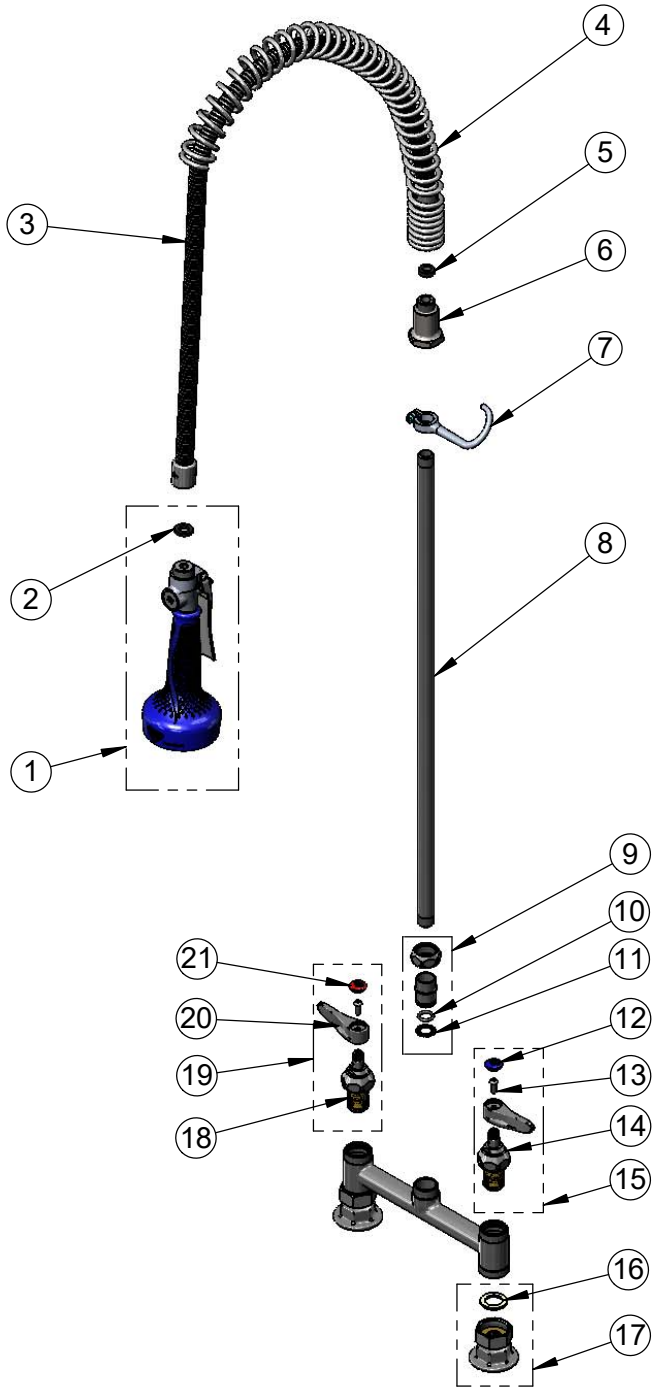

Product Specifications:

Pre-Rinse Unit: EasyInstall 8" Deck Mount Mixing Faucet, Quarter-Turn Eterna Cartridges w/ Spring Checks, Lever Handles, 44" Flexible Stainless Steel Hose, 1.07 GPM Spray Valve, 24" Riser & 1/2" NPT Female Inlets

Product Compliance:

ASME A112.18.1 / CSA B125.1
NSF 61 - Section 9
NSF 372 (Low Lead Content)
EPA Act 2005 (PRSV)