



T&S BRASS AND BRONZE WORKS, INC.

2 Saddleback Cove / P.O. Box 1088
Travelers Rest, SC 29690

Model No.

B-0108

Item No.

Travelers Rest, SC: 800-476-4103 • Simi Valley, CA: 800-423-0150 • Fax: 864-834-3518 • www.tsbrass.com

This Space for Architect/Engineer Approval

Job Name _____ Date _____

Model Specified _____ Quantity _____

Customer/Wholesaler _____

Contractor _____

Architect/Engineer _____

Extra Washer For
Hose Connections

One-Handed Metal Trigger
Lock w/ Added Anti-
Rotational Feature

Surgical-Grade
Polished
Stainless Steel

Removeable
Screen Filter

Replaceable
Cartridges

Built-In Check Valve
To Prevent Backflow

Non-Slip Ergonomic Santoprene
Grip w/ Built-in Heat Dissipation
Channels

Crush-Resistant w/ Delrin Waterways

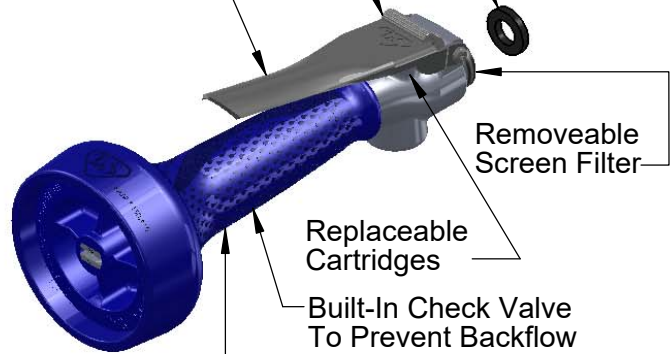
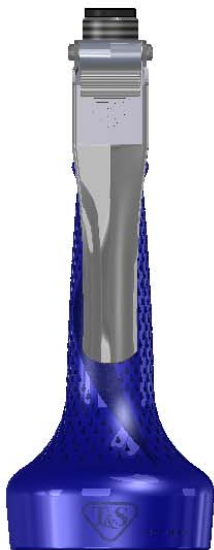

1.07 GPM @ 60 PSI
(Optional B-0108-C
0.65 GPM Available)



Ø 3 1/4"
[83mm]

8 5/16"
[212mm]

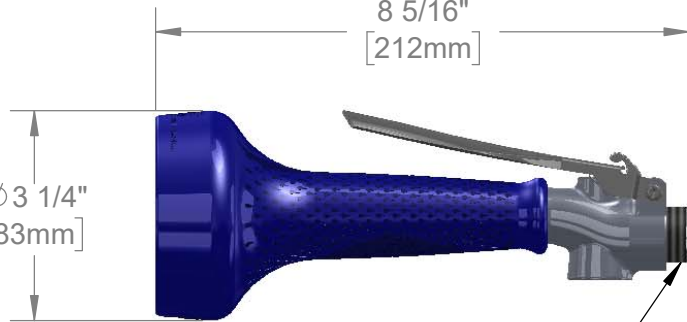

7/8-20 UN Male Inlet

Product Specifications:

**1.07 GPM Spray Valve w/ Ergo-Grip, Replaceable Spray Face
& Integrated One-Handed Trigger Lock**

Product Compliance:

ASME A112.18.1 / CSA B125.1
NSF 61 - Section 9
NSF 372 (Low Lead Content)
EPA Act 2005 (PRSV)



T&S BRASS AND BRONZE WORKS, INC.
 2 Saddleback Cove / P.O. Box 1088
 Travelers Rest, SC 29690

Model No.
B-0108

Item No.

Travelers Rest, SC: 800-476-4103 • Simi Valley, CA: 800-423-0150 • Fax: 864-834-3518 • www.tsbrass.com

ITEM NO.	SALES NO.	DESCRIPTION
1	108T-RK	Trigger Repair Kit
2	108SF-RK	Spray Face Repair Kit
3	108S-RK	Inlet Screen/Washer Repair Kit
4	108V-RK	Valve Repair Kit
5	014554-25	7/8-20 UN Close Nipple

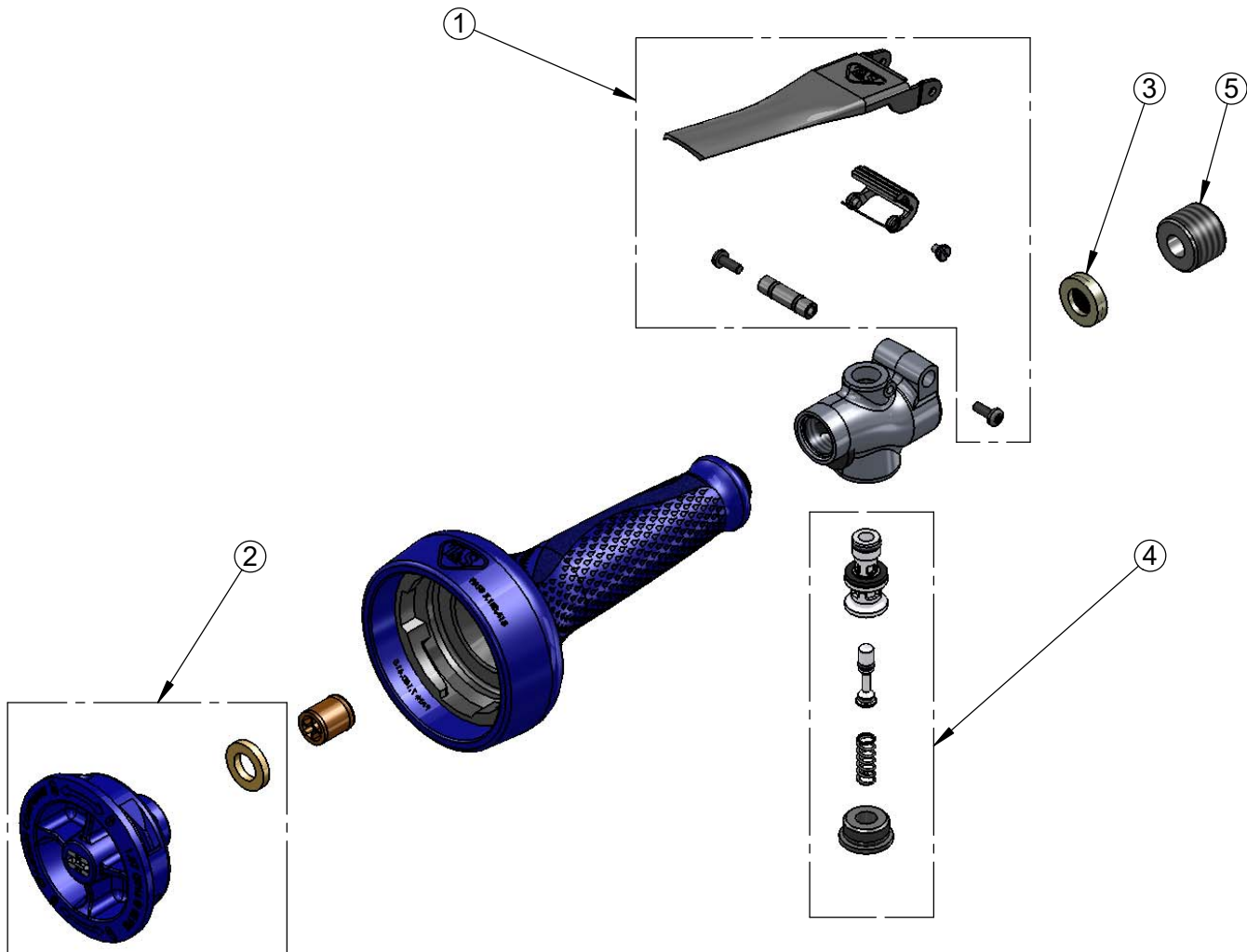

Note:
 Individual Items in Repair Kits
 are not Sold Separately

Product Specifications:
 1.07 GPM Spray Valve w/ Ergo-Grip, Replaceable Spray Face
 & Integrated One-Handed Trigger Lock

Product Compliance:
 ASME A112.18.1 / CSA B125.1
 NSF 61 - Section 9
 NSF 372 (Low Lead Content)
 EPA Act 2005 (PRSV)