



T&S BRASS AND BRONZE WORKS, INC.
 2 Saddleback Cove / P.O. Box 1088
 Travelers Rest, SC 29690

Model No.
B-0108-C

Item No.

Travelers Rest, SC: 800-476-4103 • Simi Valley, CA: 800-423-0150 • Fax: 864-834-3518 • www.tsbrass.com

This Space for Architect/Engineer Approval

Job Name _____ Date _____

Model Specified _____ Quantity _____

Customer/Wholesaler _____

Contractor _____

Architect/Engineer _____



- Extra Washer For Hose Connections
- One-Handed Metal Trigger Lock w/ Added Anti-Rotational Feature
- Surgical-Grade Polished Stainless Steel
- Removeable Screen Filter
- Replaceable Cartridges
- Built-In Check Valve To Prevent Backflow
- Non-Slip Ergonomic Santoprene Grip w/ Built-in Heat Dissipation Channels
- Crush-Resistant w/ Delrin Waterways

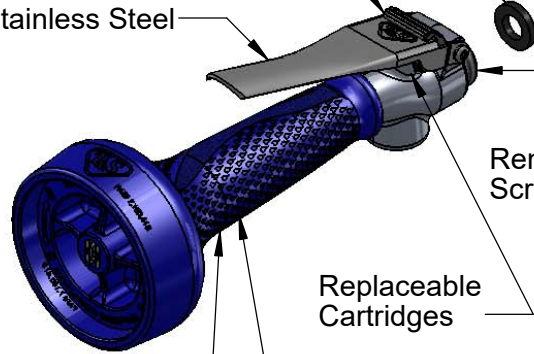
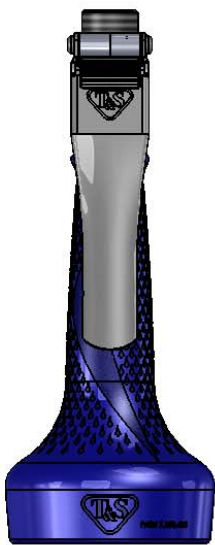

0.65 GPM @ 60 PSI
 (Optional B-0108
 1.07 GPM Available)

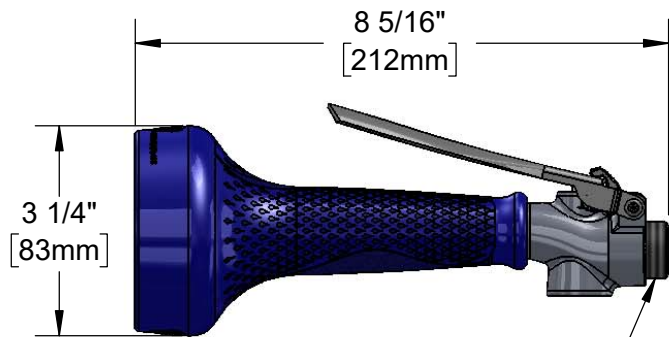

7/8-20 UN Male Inlet

Flow Rate: 0.65 GPM (2.5 Lpm) @ 60 PSI
 Spray Force: 4.6 Ozf (130 Gramf)

Product Specifications:
0.65 GPM Spray Valve w/ Ergo-Grip, Replaceable Spray Face & Integrated One-Handed Trigger Lock

Product Compliance:
 ASME A112.18.1 / CSA B125.1
 NSF 61 - Section 9
 NSF 372 (Low Lead Content)
 EPA Act 2005 (PRSV)
 EPA WaterSense (PRSV)



T&S BRASS AND BRONZE WORKS, INC.
 2 Saddleback Cove / P.O. Box 1088
 Travelers Rest, SC 29690

Model No.
B-0108-C

Item No.

Travelers Rest, SC: 800-476-4103 • Simi Valley, CA: 800-423-0150 • Fax: 864-834-3518 • www.tsbrass.com

ITEM NO.	SALES NO.	DESCRIPTION
1	108T-RK	Trigger Repair Kit
2	108CSF-RK	Spray Face Repair Kit
3	108S-RK	Inlet Screen/Washer Repair Kit
4	108V-RK	Valve Repair Kit
5	014554-25	7/8-20 UN Close Nipple

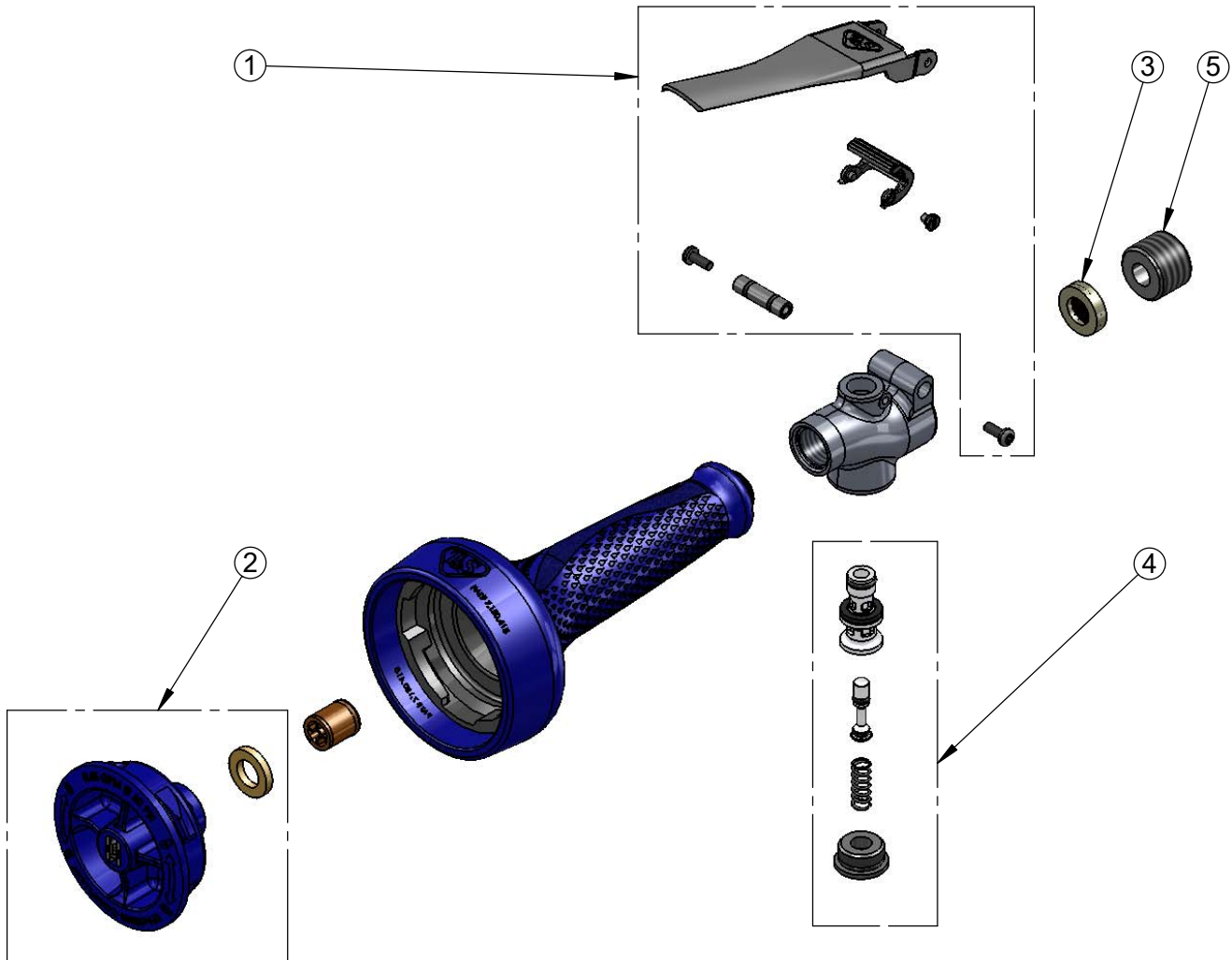

Note:
 Individual Items in Repair Kits
 are not Sold Separately

Product Specifications:
 0.65 GPM Spray Valve w/ Ergo-Grip, Replaceable Spray Face
 & Integrated One-Handed Trigger Lock

Product Compliance:
 ASME A112.18.1 / CSA B125.1
 NSF 61 - Section 9
 NSF 372 (Low Lead Content)
 EPA Act 2005 (PRSV)
 EPA WaterSense (PRSV)