



T&S BRASS AND BRONZE WORKS, INC.
 2 Saddleback Cove / P.O. Box 1088
 Travelers Rest, SC 29690

Model No.
B-0020-H2A

Item No.

Travelers Rest, SC: 800-476-4103 • Simi Valley, CA: 800-423-0150 • Fax: 864-834-3518 • www.tsbrass.com

This Space for Architect/Engineer Approval

Job Name _____ Date _____

Model Specified _____ Quantity _____

Customer/Wholesaler _____

Contractor _____

Architect/Engineer _____

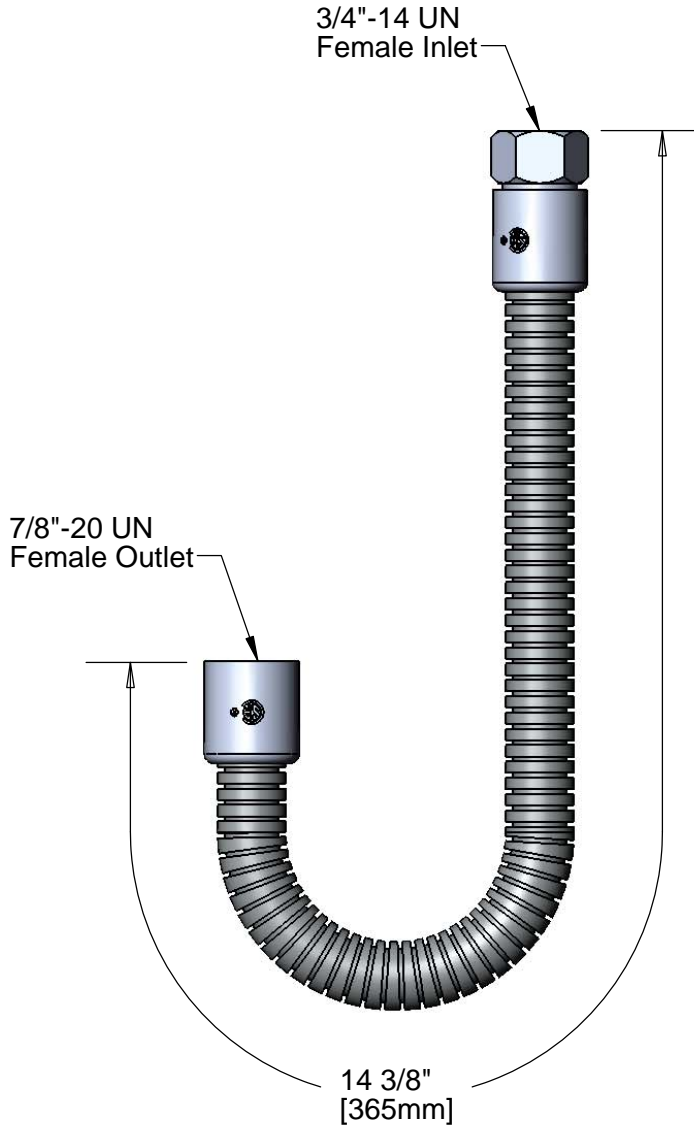

010476-45
 Washer
 (Included)



01014-45
 Washer
 (Included)

Product Specifications:
 20" Flexible Stainless Steel Hose w/ Polyurethane Inner Hose,
 Less Handle

Product Compliance:
 ASME A112.18.1 / CSA B125.1
 NSF 61 - Section 9
 NSF 372 (Low Lead Content)



T&S BRASS AND BRONZE WORKS, INC.
2 Saddleback Cove / P.O. Box 1088
Travelers Rest, SC 29690

Model No.
B-0020-H2A

Item No.

Travelers Rest, SC: 800-476-4103 • Simi Valley, CA: 800-423-0150 • Fax: 864-834-3518 • www.tsbrass.com

ITEM NO.	SALES NO.	DESCRIPTION
1	001014-45	Washer, B-0100 Hose Barrel
2	000729-40	Nut, 7/8"-20 Male x 3/4"-14 Female
3	010476-45	#27 Washer

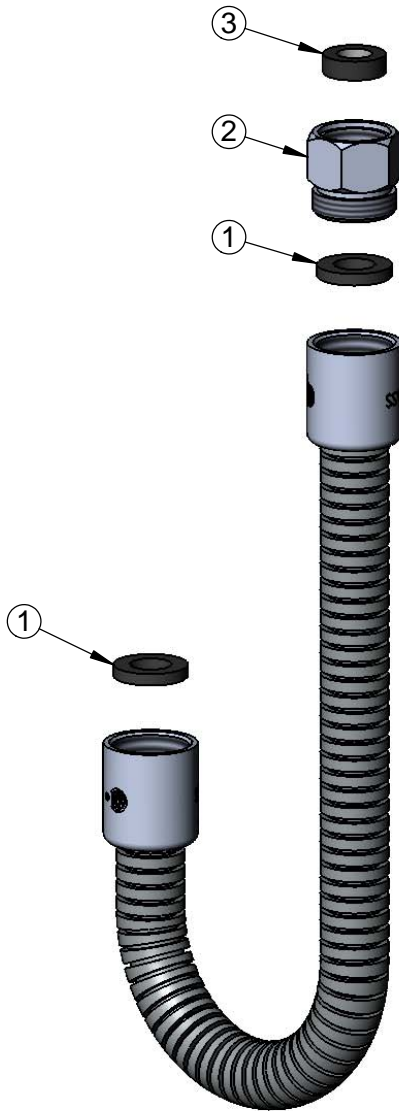

Product Specifications:
20" Flexible Stainless Steel Hose w/ Polyurethane Inner Hose,
Less Handle

Product Compliance:
ASME A112.18.1 / CSA B125.1
NSF 61 - Section 9
NSF 372 (Low Lead Content)