



**T&S BRASS AND BRONZE WORKS, INC.**  
 2 Saddleback Cove / P.O. Box 1088  
 Travelers Rest, SC 29690

Model No.  
**161X**

Item No.

Travelers Rest, SC: 800-476-4103 • Simi Valley, CA: 800-423-0150 • Fax: 864-834-3518 • www.tsbrass.com

This Space for Architect/Engineer Approval

Job Name \_\_\_\_\_ Date \_\_\_\_\_

Model Specified \_\_\_\_\_ Quantity \_\_\_\_\_

Customer/Wholesaler \_\_\_\_\_

Contractor \_\_\_\_\_

Architect/Engineer \_\_\_\_\_

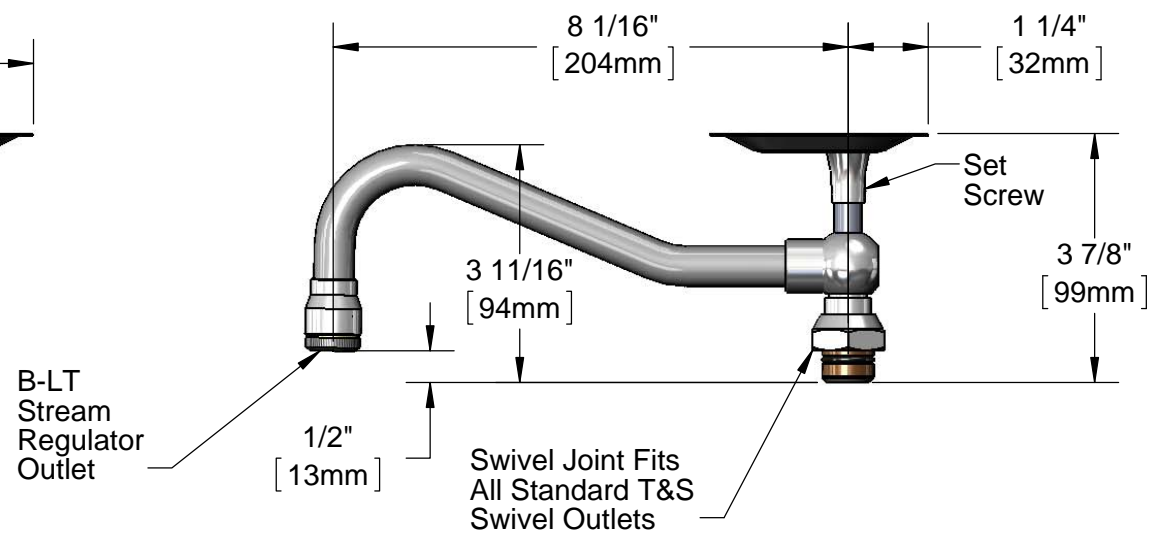
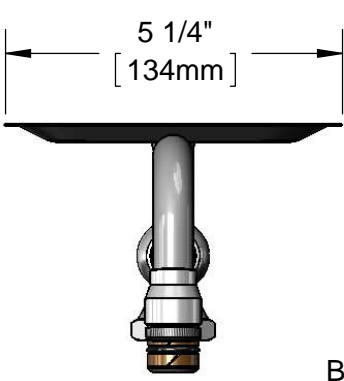
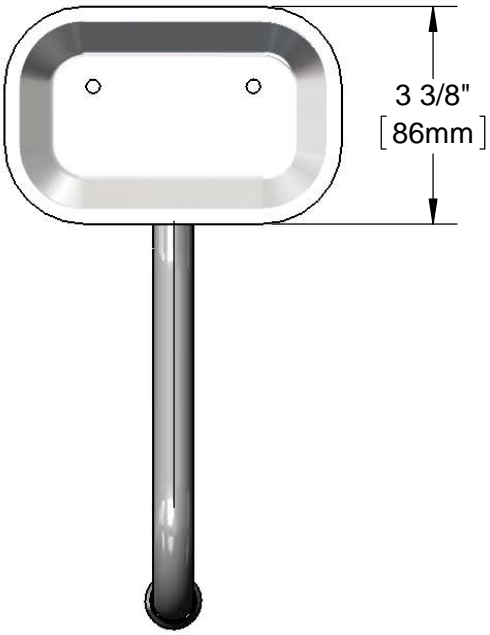

Product Specifications:  
 8" Swing Nozzle w/ Soap Dish

Drawn <b>KJG</b>	Checked <b>DMH</b>	Approved <b>JHB</b>
Scale: <b>1:3</b>		Date: <b>10/29/13</b>



**T&S BRASS AND BRONZE WORKS, INC.**  
 2 Saddleback Cove / P.O. Box 1088  
 Travelers Rest, SC 29690

Model No.  
**161X**

Item No.

Travelers Rest, SC: 800-476-4103 • Simi Valley, CA: 800-423-0150 • Fax: 864-834-3518 • www.tsbrass.com

ITEM NO.	SALES NO.	DESCRIPTION
1	B-LT	Stream Regulator Outlet
2	001043-45	Washer
3	000557-25	Bell Adapter, 5/8-27 UN Female x 3/8" NPSM Female
4	000286-40	8" Nozzle
5	000939-45	Set Screw
6	B-SD	Soap Dish
7	000711-40	Swivel Nut
8	009E	Plastic Washer
9	000843-25	Swivel Body
10	011429-45	Swivel Sleeves (2)
11	001074-45	O-Ring

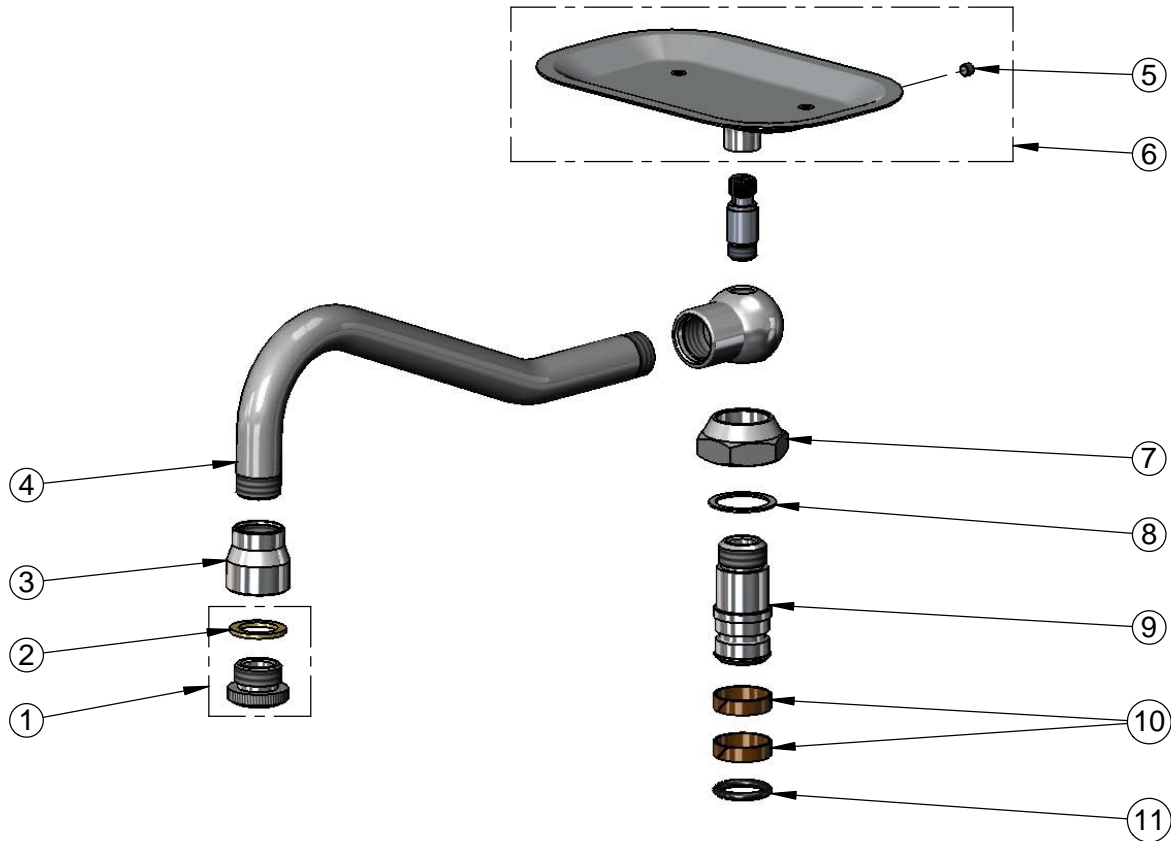

Product Specifications:  
 8" Swing Nozzle w/ Soap Dish

Drawn <b>KJG</b>	Checked <b>DMH</b>	Approved <b>JHB</b>
Scale: <b>NTS</b>		Date: <b>10/29/13</b>