



T&S BRASS AND BRONZE WORKS, INC.
 2 SADDLEBACK COVE / P.O. BOX 1088 / TRAVELERS REST, SC 29690
 PHONE 800-476-4103 FAX 864- 834-3518



Model No.

078A

Item No.:

Job Name:

Architect/Engineer Approval:

Notes:



ADA COMPLIANT

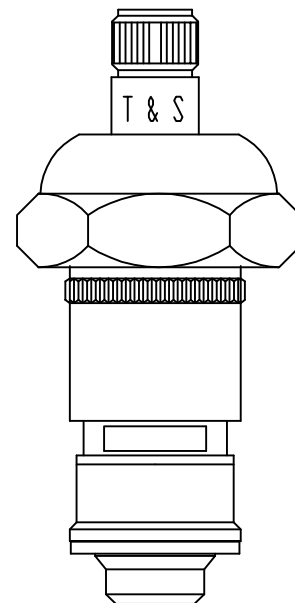
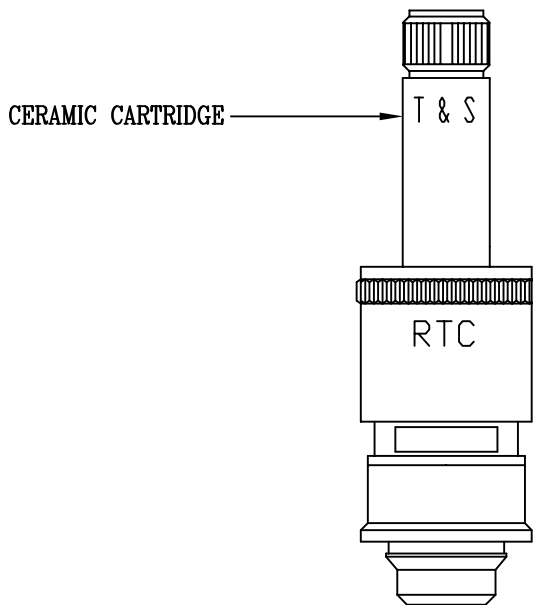
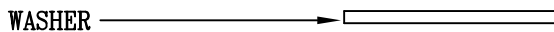
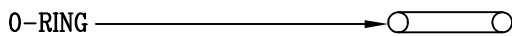
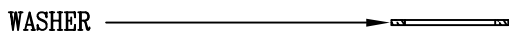
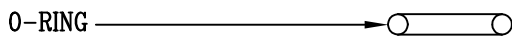
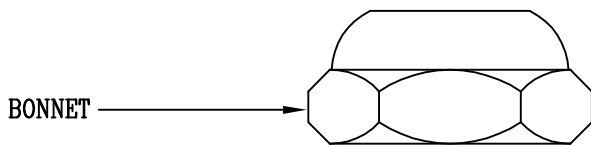

COMPLETED 78-A

Product Description:

RIGHT TURN CERAMIC CARTRIDGE ASM.
 FOR MODELS WITHOUT ESCUTCHEONS

Drawn:

WJS

Checked

MVW

Scale:

1:1

Approved

MVW

Date:

12/22/97