



T&S BRASS AND BRONZE WORKS, INC.
 2 Saddleback Cove / P.O. Box 1088
 Travelers Rest, SC 29690

Model No.
019303-45

Item No.

Travelers Rest, SC: 800-476-4103 • Simi Valley, CA: 800-423-0150 • Fax: 864-834-3518 • www.tsbrass.com

This Space for Architect/Engineer Approval

Job Name _____ Date _____

Model Specified _____ Quantity _____

Customer/Wholesaler _____

Contractor _____

Architect/Engineer _____

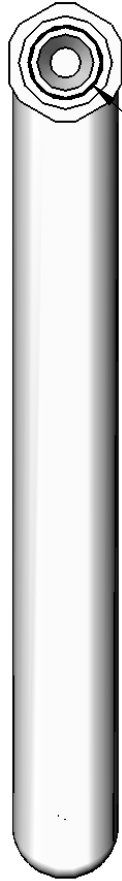

Inlet Fits EA-6WF Series Faucets

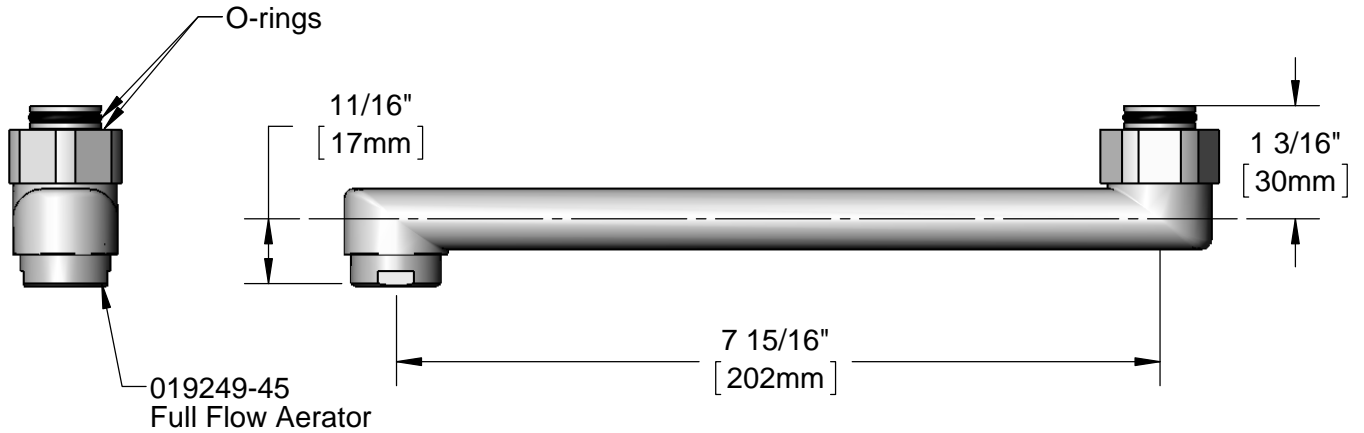
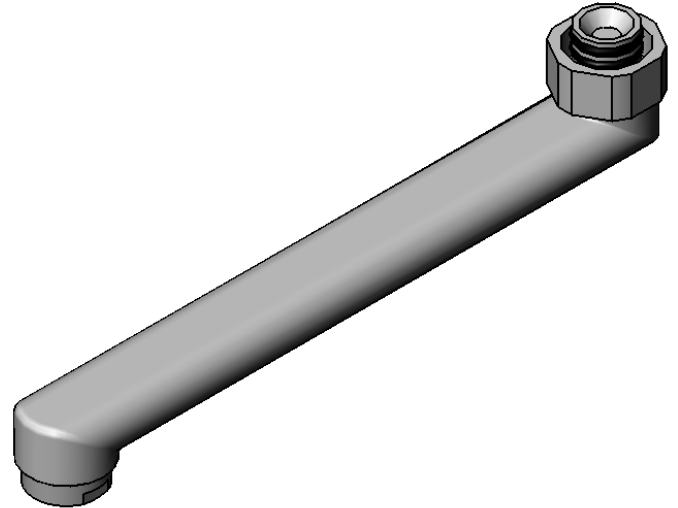

Product Specifications:
 8" Submarine Swing Nozzle w/ Full Flow Aerator

Drawn KJG	Checked JRM	Approved JHB
Scale: 1:2		Date: 05/14/15