



# T&S BRASS AND BRONZE WORKS, INC.

2 Saddleback Cove / P.O. Box 1088  
Travelers Rest, SC 29690



REG. #A2601  
ISO #9001

Model No.

**000592-25**

Item No.

Travelers Rest, SC: 800-476-4103 • Simi Valley, CA: 800-423-0150 • Fax: 864-834-3518 • www.tsbrass.com

This Space for Architect/Engineer Approval

Job Name \_\_\_\_\_ Date \_\_\_\_\_

Model Specified \_\_\_\_\_ Quantity \_\_\_\_\_

Customer/Wholesaler \_\_\_\_\_

Contractor \_\_\_\_\_

Architect/Engineer \_\_\_\_\_

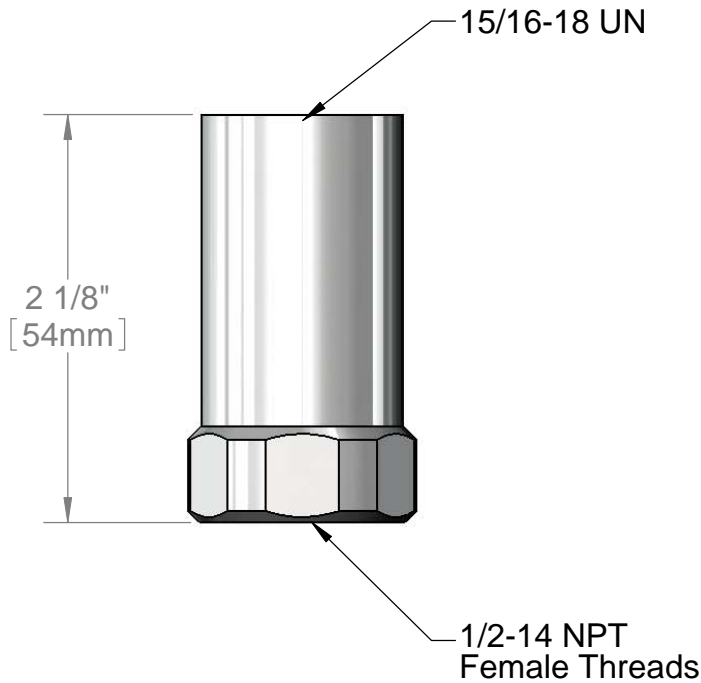
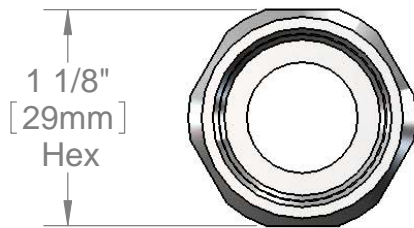
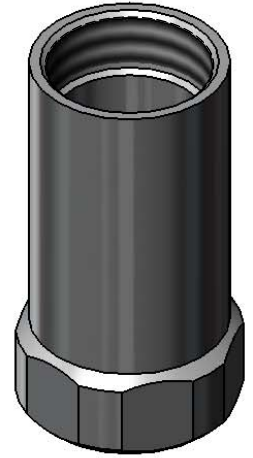

Product Specifications:  
Pre-Rinse Swivel Body, 1/2" NPT

Drawn

**KJG**

Checked

**DHL**

Approved

**JHB**

Scale:

**1:1**

Date:

**12/07/10**